

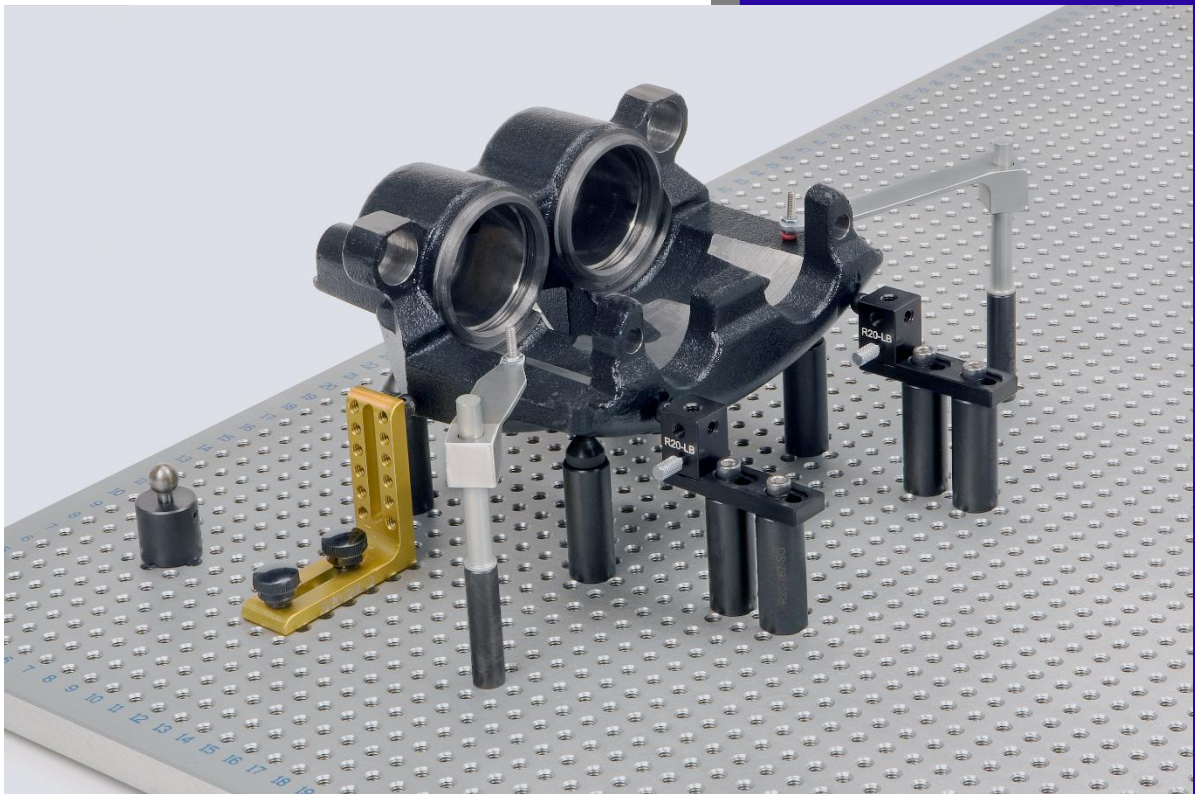

Catalog 17.1



5520 Bridgewood Drive
Sterling Heights, MI 48310

Office: (586)795-2884
Fax: (586)795-3260
Email: sales@raycofixture.com

www.raycofixture.com

TABLE OF CONTENTS

FIXTURE PLATES

Aluminum	1
Steel	2
Round	3
Vision Plates & RVFL's	4

CUSTOM FIXTURES

5

METROLOGY TABLES

6

COMPONENT KITS

Standard Clamping Kits	7-10
Magnetic Clamping Kits	11-14
Vacuum Kits	15-17
Vision Kits	18-20

ACCESSORIES & COMPONENTS

21-38

ALUMINUM EXTRUSION KITS & COMPONENTS

AX Kits	39
AX Components	40-41



Aluminum Fixture Plates

Our Standard Cast Aluminum Plates are protected with a clear hard lube anodize with engraved numbers in the X-axis and letters in the Y-axis.

- Customize your plate size, hole spacing and thread type.
- Mounting Holes and fasteners are included at no added cost.

1/4-20 Thread

Part Number	Length	Width	Thickness	Hole Spacing
R20-66375-50	6"	6"	.375"	1/2"
R20-121250-50	12"	12"	1/2"	1/2"
R20-151550-50	15"	15"	1/2"	1/2"
R20-181850-50	18"	18"	1/2"	1/2"
R20-242450-50	24"	24"	1/2"	1/2"
R20-242475-50	24"	24"	3/4"	1/2"
R20-284075-50	28"	40"	3/4"	1/2"
R20-303075-50	30"	30"	3/4"	1/2"

M8 Thread

Part Number	Length	Width	Thickness	Hole Spacing
R8-30030013-15	300 mm	300 mm	13 mm	15 mm
R8-45045013-15	450 mm	450 mm	13 mm	15 mm
R8-60060013-15	600 mm	600 mm	13 mm	15 mm
R8-60060019-15	600 mm	600 mm	19 mm	15 mm
R8-75075019-15	750 mm	750 mm	19 mm	15 mm

M6 Thread

Part Number	Length	Width	Thickness	Hole Spacing
R6-30030013-15	300 mm	300 mm	13 mm	15 mm
R6-45045013-15	450 mm	450 mm	13 mm	15 mm
R6-60060013-15	600 mm	600 mm	13 mm	15 mm
R6-60060019-15	600 mm	600 mm	19 mm	15 mm

M4 Thread

Part Number	Length	Width	Thickness	Hole Spacing
R4-15015010-10	150 mm	150 mm	10 mm	10 mm

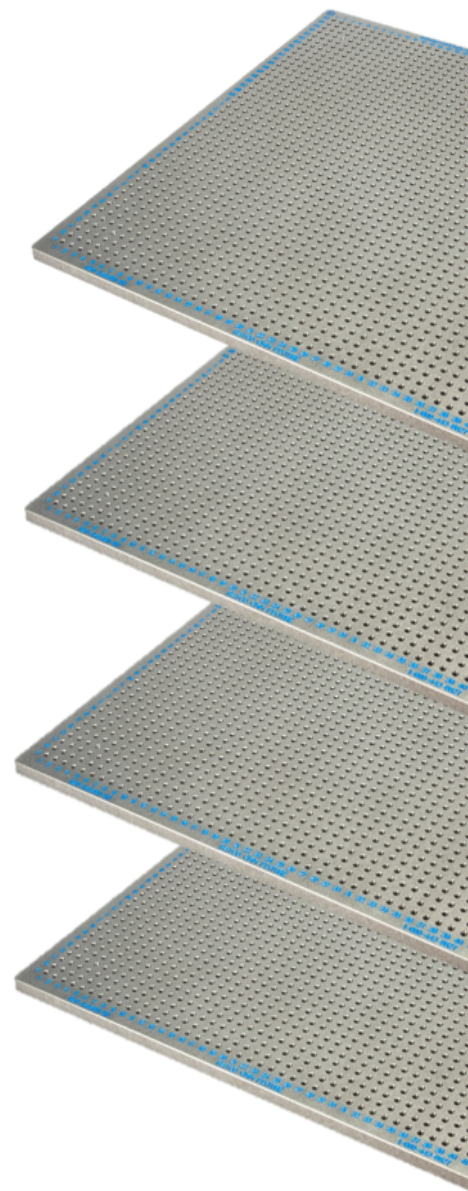

Steel Fixture Plates

Our Steel Fixture Plates are hardened to 28/32 RC for durability and have a Black Oxide Coating with engraved numbers in the X-axis and letters in the Y-axis.

- Customize your plate size, hole spacing and thread type.
- Mounting Holes and Fasteners are included at no added cost.

1/4-20 Thread

Part Number	Length	Width	Thickness	Hole Spacing
R20-181875-50-S	18"	18"	3/4"	1/2"
R20-242475-50-S	24"	24"	3/4"	1/2"
R20-30301-50-S	30"	30"	1"	1/2"

M8 Thread

Part Number	Length	Width	Thickness	Hole Spacing
R8-45045019-15-S	450 mm	450 mm	19 mm	15 mm
R8-60060019-15-S	600 mm	600 mm	19 mm	15 mm
R8-75075025-15-S	750 mm	750 mm	25 mm	15 mm

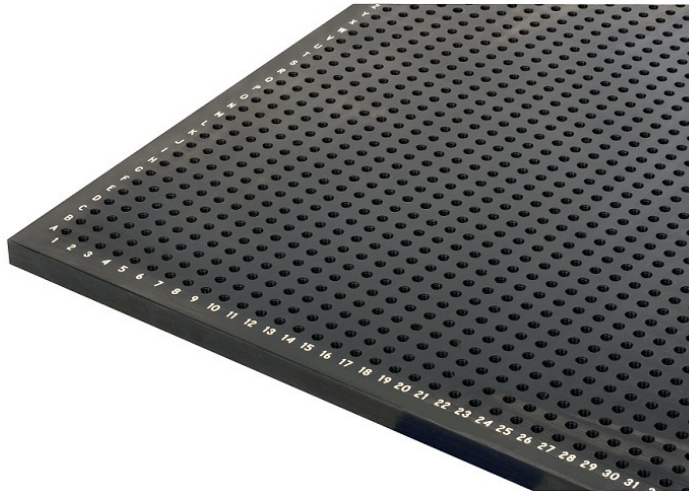

Round Fixture Plates

Our Round Fixture plates are protected with a clear hard lube anodize with engraved numbers in the X-axis and Letters in the Y-axis through the diameter of the plate.

- Customize your plate size, hole spacing and thread type.
- Mounting Holes and Fasteners are included at no added cost.
- Rotational Base Upon Request.

1/4-20 Thread

Park Number	Diameter	Thickness	Hole Spacing
R20-650-50-RR	6"	1/2"	1/2"
R20-850-50-RR	8"	1/2"	1/2"
R20-1850-50-RR	18"	1/2"	1/2"
R20-2475-50-RR	24"	3/4"	1/2"

M8 Thread

Park Number	Diameter	Thickness	Hole Spacing
R8-30013-15-RR	300 mm	13 mm	15 mm
R8-45013-15-RR	450 mm	13 mm	15 mm
R8-60019-15-RR	600 mm	19 mm	15 mm
R8-90019-15-RR	900 mm	19 mm	15 mm

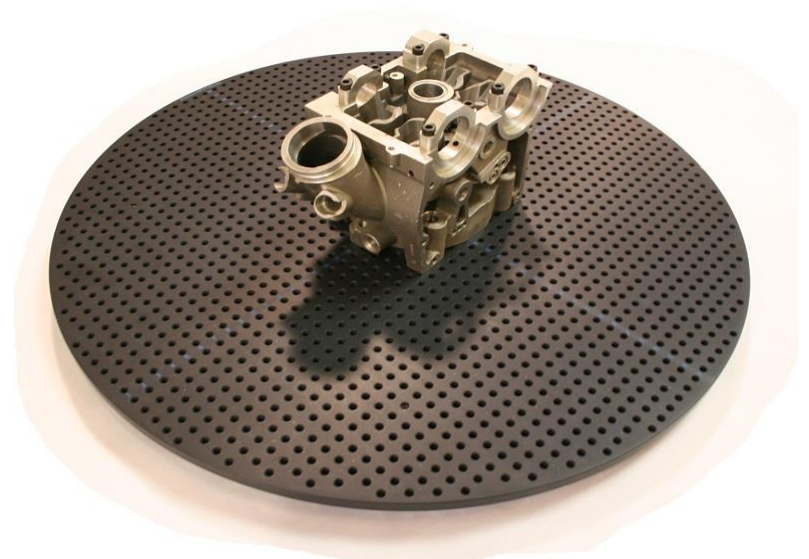
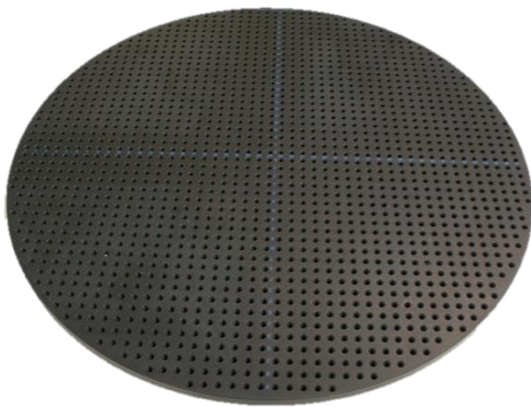

Vision Plates & RVFL's

Rayco Acrylic Plates are made from optical grade acrylic with engraved numbers in the X-Axis and letters in the Y-Axis. Steel edge inserts are added to each plate to work with our magnetic RVFL system. The RVFL mounts to the outer stage of your vision machine and allows for a quick plate change.

- Customize your plate size, hole spacing and thread type.
- Viewing Window to Customer specifications
- Full Frame Fixtures Available Upon Request

1/4-20 Thread

Part Number	Length	Width	Thickness	Hole Spacing
RA20-060650-50	6"	6"	1/2"	1/2"
RA20-121275-50	12"	12"	3/4"	1/2"
RA20-140975-50	14"	9"	3/4"	1/2"

M4 Thread

Part Number	Length	Width	Thickness	Hole Spacing
RA4-15015013-10	150 mm	150 mm	13 mm	10 mm
RA4-30030019-15	300 mm	300 mm	19 mm	15 mm
RA4-40040019-15	400 mm	400 mm	19 mm	15 mm

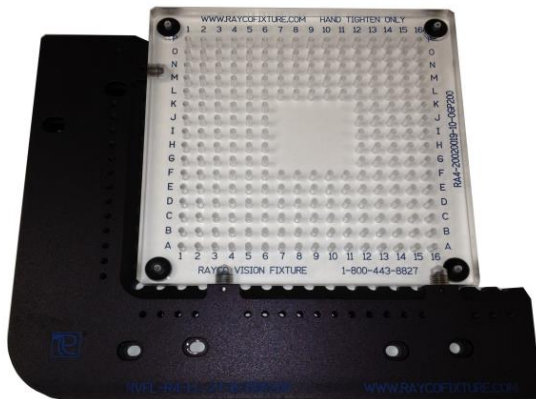

Rayco Vision Fixture Locator (RVFL)

Part Number	Plate Match
RVFLII-1	< 160 mm / 6.25"
RVFLII-2	161 mm - 300 mm / 12"
RVFLII-3	301 mm - 450 mm / 18"
RVFLII-4	451 mm - 600 mm / 23"
RVFLII-5	601 mm / 24"+

Custom Fixtures



Rayco Fixture also excels in making custom fixtures to fit any part. Whether dedicated or adjustable, we can make a fixture to fit your needs. We have made fixtures for many applications, such as:

- CMM
- Vision System
- Quick Check
- Assembly
- Welding

Get your personalized quote today!



Multiple Setups, ONE Fixture!

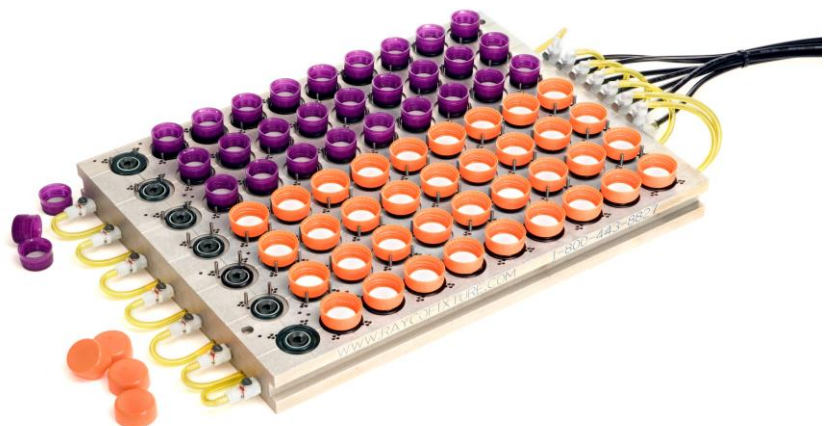

Metrology Tables

"Perfect for your Portable Measurement Device"

Rayco's Metrology Table frames are constructed from extruded aluminum and are matched with a Rayco Fixture Plate of your choice (plate sold separately). Includes Premium "non-grooved" material on the outside surface of frame. Each table is made to order.

Portable Metrology Tables

Part Number	Length	Width	Height
R-2436-MT	24"	36"	36"
R-3648-MT	36"	48"	36"
R-4260-MT	42"	60"	36"
R-4872-MT	48"	72"	36"
R-4878-MT	48"	78"	36"
R-6096-MT	60"	96"	36"

Features:

- (2) Heavy Duty Fixed Wheels
- (2) Heavy Duty Swivel Wheels
- (4) Foot Operated Floor Locks
- (1) 1/4" Black ABS Bottom Shelf

Stationary Metrology Tables

Part Number	Length	Width	Height
R-2436-SMT	24"	36"	36"
R-3648-SMT	36"	48"	36"
R-4872-SMT	42"	60"	36"
R-4878-SMT	48"	72"	36"
R-4260-SMT	48"	78"	36"
R-6096-SMT	60"	96"	36"

Features:

- (1) 1/4" Black ABS Bottom Shelf
- NO Wheels
- NO Floor Locks



Floor-Locks

Portable Aluminum Table

Clamping Kits: 1/4-20 Thread



R20-CK-C

Part Numbers	Description	R20-CK-A	R20-CK-B	R20-CK-C
R20-37550-SO	3/8" Dia. x 1/2" Standoff		3	6
R20-5050-SO	1/2" Dia. X 1/2" Standoff			4
R20-5075-SO	1/2" Dia. X 3/4" Standoff	3	6	8
R20-501-SO	1/2" Dia. X 1" Standoff	3	6	8
R20-502-SO	1/2" Dia. X 2" Standoff	3	6	8
R20-7550-SO	3/4" Dia. X 1/2" Standoff		3	4
R20-7575-SO	3/4" Dia. X 3/4" Standoff	3	6	8
R20-751-SO	3/4" Dia. X 1" Standoff	3	6	8
R20-752-SO	3/4" Dia. X 2" Standoff	3	6	8
R20-754-SO	3/4" Dia. X 4" Standoff		4	6
R20-175-SO	1" Dia. X 3/4" Standoff	3	6	8
R20-11-SO	1" Dia. X 1" Standoff	3	6	8
R20-12-SO	1" Dia. X 2" Standoff	3	6	8
R20-14-SO	1" Dia. X 4" Standoff		4	6
R20-501-PSO:	1/2" Dia. X 1" Pin Standoff	2	4	4
R20-7575-PSO	3/4" Dia. X 3/4" Pin Standoff			2
R20-ST5-15	Small Tension Spring - 1.5" Post	2	6	6
R20-LTS-3	Large Tension Spring - 3" Post	4	12	12
R20-XLTS	X-Large Tension Spring - 3" Post			3
R20-XLTSP	X-Large Tension Spring with Plunger			3
R20-1-TSB	1" Dia. Tension Spring Bracket			1
R20-NC	Nylon Cone	3	4	6
R20-SRP	Steel Resting Pin		4	6
R20-APJ	Adjustable Pivot Joint			1
R20-50-JS	1/2" Dia. Jackstand	1	2	3
R20-1-JS	1" Dia. Jackstand		2	3
R20-MSLD	Mini Slide Base	1	2	3
R20-SLD	Slide Base	1	2	4
R20-LB	Locating Block with Base		2	2
R20-112-MT4	1" Sq. x 12" Mini Tower			1
R20-SCT	1/4-20 Small Component Tray	1		
R-CASE-B	Case for B Kit (1 Layer)		1	
R-CASE-C	Case for C Kit (2 Layers)			1
Total Components		42	109	159

Clamping Kits: M8 Thread



Part Numbers	Description	R8-CK-A	R8-CK-B	R8-CK-C
R8-1315-SO	13mm Dia. X 15mm Standoff		3	4
R8-1320-SO	13mm Dia. X 20mm Standoff	3	6	8
R8-1325-SO	13mm Dia. X 25mm Standoff	3	6	8
R8-1350-SO	13mm Dia. X 50mm Standoff	3	6	8
R8-1915-SO	19mm Dia. X 15mm Standoff		3	4
R8-1920-SO	19mm Dia. X 20mm Standoff	3	6	8
R8-1925-SO	19 mm Dia. X 25 mm Standoff	3	6	8
R8-1950-SO	19mm Dia. X 50mm Standoff	3	6	8
R8-19100-SO	19mm Dia. X 100mm Standoff		4	6
R8-2520-SO	25mm Dia. X 20mm Standoff	3	6	8
R8-2525-SO	25mm Dia. X 25mm Standoff	3	6	8
R8-2550-SO	25mm Dia. X 50mm Standoff	3	6	8
R8-25100-SO	25mm Dia. X 100mm Standoff		4	6
R8-1325-PSO	13mm Dia. X 25mm Pin Standoff	2	4	6
R8-ST5-38	Small Tension Spring - 38mm Post	2	6	6
R8-LTS-75	Large Tension Spring - 75mm Post	4	12	12
R8-XLTS	X-Large Tension Spring - 75mm Post			3
R8- XLTSP	X-Large Tension Spring with Plunger			3
R8-25-TSB	25mm Dia. Tension Spring Bracket			1
R8-NC	Nylon Cone	3	4	4
R8-SC	Steel Cone		4	4
R8-PJ	Pivot Joint			1
R8-19-JS	19mm Dia. Small Jackstand	1	2	4
R8-25-JS	25mm Dia. Large Jackstand		2	3
R8-SLD	Slide Base	1	3	6
R8-LB	Locating Block with Base		2	2
R8-25300-MT4	25mm Sq. X 300mm Mini Tower			1
R8-SCT	M8 Small Component Tray	1		
R-CASE-B	Case for B Kit (1 Layer)		1	
R-CASE-C	Case for C Kit (2 Layers)			1
Total Components		41	108	149

Clamping Kits: M6 Thread



R6-CK-C

Part Numbers	Description	R6-CK-A	R6-CK-B	R6-CK-C
R6-910-SO	9mm Dia. x 10mm Standoff		3	6
R6-1310-SO	13mm Dia. x 10mm Standoff			4
R6-1320-SO	13mm Dia. X 20mm Standoff	3	6	8
R6-1325-SO	13mm Dia. X 25mm Standoff	3	6	8
R6-1350-SO:	13mm Dia. X 50mm Standoff	3	6	8
R6-1910-SO	19mm Dia. X 10mm Standoff		3	4
R6-1920-SO	19mm Dia. X 20mm Standoff	3	6	8
R6-1925-SO	19 mm Dia. X 25 mm Standoff	3	6	8
R6-1950-SO	19mm Dia. X 50mm Standoff	3	6	8
R6-19100-SO	19mm Dia. X 100mm Standoff		4	6
R6-2520-SO	25mm Dia. X 20mm Standoff	3	6	8
R6-2525-SO	25mm Dia. X 25mm Standoff	3	6	8
R6-2550-SO	25mm Dia. X 50mm Standoff	3	6	8
R6-25100-SO	25mm Dia. X 100mm Standoff		4	6
R6-1325-PSO	13mm Dia. X 25mm Pin Standoff	2	4	4
R6-1920-PSO	19mm Dia. X 20mm Pin Standoff			2
R6-ST3-38	Small Tension Spring - 38mm Post	2	6	6
R6-LTS-75	Large Tension Spring - 75mm Post	4	12	12
R6-XLTS	X-Large Tension Spring			3
R6-XLTSP	X-Large Tension Spring with Plunger			3
R6-25-TSB	25mm Dia. Tension Spring Bracket			1
R6-NC	Nylon Cone	3	4	6
R6-SRP	Steel Resting Pin		4	6
R6-APJ	Adjustable Pivot Joint			1
R6-13-JS	13mm Dia. Jackstand	1	2	3
R6-25-JS	25mm Dia. Jackstand		2	3
R6-MSLD	Mini Slide base	1	2	3
R6-SLD	Slide Base	1	2	4
R6-LB	Locating Block with Base		2	2
R6-25300-MT4	25mm sq. x 300mm Mini Tower			1
R6-SCT	M6 Small Component Tray	1		
R-CASE-B	Case for B Kit (1 Layer)		1	
R-CASE-C	Case for C Kit (2 Layers)			1
Total Components		42	109	159

Clamping Kits: M4 Thread



Part Numbers	Description	R4-CK-A	R4-CK-B
R4-65-SO	6mm Dia. X 5mm Standoff		3
R4-610-SO	6mm Dia. X 10mm Standoff	2	6
R4-625-SO	6mm Dia. X 25mm Standoff	4	6
R4-95-SO	9mm Dia. X 5mm Standoff	3	3
R4-910-SO	9mm Dia. X 10mm Standoff	3	6
R4-920-SO	9mm Dia. X 20mm Standoff		6
R4-925-SO	9mm Dia. X 25mm Standoff	4	6
R4-1210-SO	12mm Dia. X 10mm Standoff	3	6
R4-1225-SO	12mm Dia. X 25mm Standoff	4	6
R4-610-PSO	6mm Dia. X 10mm Pin Standoff	3	4
R4-910-PSO	9mm Dia. X 10mm Pin Standoff	2	4
R4-1210-PSO	12mm Dia. X 10mm Pin Standoff		4
R4-MTS-25	Mini Tension Spring - 25mm Post		4
R4-WTS-32-50	32mm Wire Tension Spring - 50mm Post	3	4
R4-WTS-50-50	50mm Wire Tension Spring - 50mm Post	2	4
R4-STS-50	Small Tension Spring - 50mm Post	2	4
R4-MSLD	Mini Slide Base	1	2
R4-MJS	Mini JackStand	1	2
R4-ARP	Aluminum Resting Pin	5	4
R4-LB	Locating Block with Base		1
R4-MCV	Mini Corner Viewer	1	1
R4-PC	Pusher Clamp		1
R4-MCT	M4 Mini Component Tray		1
AX-BOX	Organizer Box	1	
Total Components		44	88

Magnetic Clamping Kits: ¼-20 Thread



Part Numbers	Description	R20-MCK-A	R20-MCK-B	R20-MCK-C
R20-50-M	1/2" Dia. Magnet	3	4	6
R20-75-M	3/4" Dia. Magnet	3	4	6
R20-1-M	1" Dia. Magnet	3	4	6
R20-50-PM	1/2" Dia. Pin Magnet		2	2
R20-75-PM	3/4" Dia. Pin Magnet			2
R20-37550-SO	3/8" Dia. x 1/2" Standoff		3	4
R20-5050-SO	1/2" Dia. X 1/2" Standoff			4
R20-5075-SO	1/2" Dia. X 3/4" Standoff	3	6	8
R20-501-SO	1/2" Dia. X 1" Standoff	3	6	8
R20-502-SO	1/2" Dia. X 2" Standoff	3	6	8
R20-7550-SO	3/4" Dia. X 1/2" Standoff		3	4
R20-7575-SO	3/4" Dia. X 3/4" Standoff	3	6	8
R20-751-SO	3/4" Dia. X 1" Standoff	3	6	8
R20-752-SO	3/4" Dia. X 2" Standoff	3	6	8
R20-754-SO	3/4" Dia. X 4" Standoff		3	6
R20-175-SO	1" Dia. X 3/4" Standoff	3	6	8
R20-11-SO	1" Dia. X 1" Standoff	3	6	8
R20-12-SO	1" Dia. X 2" Standoff	3	6	8
R20-14-SO	1" Dia. X 4" Standoff		3	6
R20-ST3-3	Small Tension Spring - 3" Post	4		
R20-ST3-15	Small Tension Spring - 15" Post		4	4
R20-LTS-3	Large Tension Spring - 3" Post		8	8
R20-XLTS	X-Large Tension Spring - 3" Post			2
R20-1-TSB	1" Dia. Tension Spring Bracket			1
R20-NC	Nylon Cone	3	4	6
R20-SRP	Steel Resting Pin		4	6
R20-APJ	Adjustable Pivot Joint			1
R20-50-JS	1/2" Dia. Jackstand	1	2	3
R20-1-JS	1" Dia. Jackstand		2	3
R20-MSLD	Mini Slide Base	1	2	3
R20-SLD	Slide Base	1	2	3
R20-LB	Locating Block with Base		2	2
R20-112-MT4	1" Sq. x 12" Mini Tower			1
R20-SCT	1/4-20 Small Component Tray	1	1	2
Total Components		47	111	163

Magnetic Clamping Kits: M8 Thread



Part Numbers	Description	R8-MCK-A	R8-MCK-B	R8-MCK-C
R8-13-M	13mm Dia. Magnet	3	4	6
R8-19-M	19mm Dia. Magnet	3	4	6
R8-25-M	25mm Dia. Magnet	3	4	6
R8-13-PM	13mm Dia. Pin Magnet		2	2
R8-19-PM	19mm Dia. Pin Magnet			2
R8-1315-SO	13mm Dia. X 15mm Standoff		3	3
R8-1320-SO	13mm Dia. X 20mm Standoff	3	6	8
R8-1325-SO	13mm Dia. X 25mm Standoff	3	6	8
R8-1350-SO	13mm Dia. X 50mm Standoff	3	6	8
R8-1915-SO	19mm Dia. X 15mm Standoff		3	3
R8-1920-SO	19mm Dia. X 20mm Standoff	3	6	8
R8-1925-SO	19mm Dia. X 25mm Standoff	3	6	8
R8-1950-SO	19mm Dia. X 50mm Standoff	3	6	8
R8-19100-SO	19mm Dia. X 100mm Standoff		4	6
R8-2520-SO	25mm Dia. X 20mm Standoff	3	6	8
R8-2525-SO	25mm Dia. X 25mm Standoff	3	6	8
R8-2550-SO	25mm Dia. X 50mm Standoff	3	6	8
R8-25100-SO	25mm Dia. X 100mm Standoff		4	6
R8-STS-38	Small Tension Spring - 38mm Post		4	4
R8-LTS-75	Large Tension Spring - 75mm Post	3	8	8
R8-XLTS	X-Large Tension Spring - 75mm Post			2
R8-25-TSB	25mm Dia. Tension Spring Bracket			1
R8-NC	Nylon Cone	3	4	4
R8-SC	Steel Cone		4	4
R8-PJ	Pivot Joint			1
R8-19-JS	19mm Dia. Small Jackstand	1	2	3
R8-25-JS	25mm Dia. Large Jackstand		2	3
R8-SLD	Slide Base	1	3	5
R8-LB	Locating Block with Base		2	2
R8-25300-MT4	25mm Sq. X 300mm Mini Tower			1
R8-SCT	M8 Small Component Tray	1	1	2
Total Components		45	112	152

Magnetic Clamping Kits: M6 Thread



Part Numbers	Description	R6-MCK-A	R6-MCK-B	R6-MCK-C
R6-13-M	13mm Dia. Magnet	3	4	6
R6-19-M	19mm Dia. Magnet	3	4	6
R6-25-M	25mm Dia. Magnet	3	4	6
R6-13-PM	13mm Dia. Pin Magnet		2	2
R6-19-PM	19mm Dia. Pin Magnet			2
R6-910-SO	9mm Dia. X 10mm Standoff		3	4
R6-1310-SO	13mm Dia. X 10mm Standoff			4
R6-1320-SO	13mm Dia. X 20mm Standoff	3	6	8
R6-1325-SO	13mm Dia. X 25mm Standoff	3	6	8
R6-1350-SO	13mm Dia. X 50mm Standoff	3	6	8
R6-1910-SO	19mm Dia. X 10mm Standoff		3	4
R6-1920-SO	19mm Dia. X 20mm Standoff	3	6	8
R6-1925-SO	19mm Dia. X 25mm Standoff	3	6	8
R6-1950-SO	19mm Dia. X 50mm Standoff	3	6	8
R6-19100-SO	19mm Dia. X 100mm Standoff		3	6
R6-2520-SO	25mm Dia. X 20mm Standoff	3	6	8
R6-2525-SO	25mm Dia. X 25mm Standoff	3	6	8
R6-2550-SO	25mm Dia. X 50mm Standoff	3	6	8
R6-25100-SO	25mm Dia. X 100mm Standoff		3	6
R6-ST3-38	Small Tension Spring - 38mm Post		4	4
R6-LTS-75	Large Tension Spring - 75mm Post	3	8	8
R6-XLTS	X-Large Tension Spring - 75mm Post			2
R6-25-TSB	25mm Dia. Tension Spring Bracket			1
R6-NC	Nylon Cone	3	4	6
R6-SRP	Steel Resting Pin		4	6
R6-APJ	Adjustable Pivot Joint			1
R6-13-JS	13mm Dia. Small Jackstand	1	2	3
R6-25-JS	25mm Dia. Large Jackstand		2	3
R6-MSLD	Mini Slide Base		2	3
R6-SLD	Slide Base	1	2	3
R6-LB	Locating Block with Base		2	2
R6-25300-MT4	25mm sq. x 300mm Mini Tower			1
R6-SCT	M6 Small Component Tray	1	1	2
Total Components		45	111	163

Magnetic Clamping Kits: M4 Thread



Part Numbers	Description	R4-MCK-A
R4-6-M	6mm Dia. Magnet	3
R4-13-M	13mm Dia. Magnet	3
R4-6-PM	6mm Dia. Pin Magnet	3
R4-65-SO	6mm Dia. X 5mm Standoff	3
R4-610-SO	6mm Dia. X 10mm Standoff	3
R4-625-SO	6mm Dia. X 25mm Standoff	3
R4-95-SO	9mm Dia. X 5mm Standoff	3
R4-910-SO	9mm Dia. X 10mm Standoff	3
R4-925-SO	9mm Dia. X 25mm Standoff	3
R4-625-PSO	6mm Dia. X 25mm Pin Standoff	3
R4-MTS-25	Mini Tension Spring - 25mm Post	2
R4-MTS-50	Mini Tension Spring - 50mm Post	2
R4-WTS-32-25	32mm Wire Tension Spring - 25mm Post	2
R4-WTS-50-50	50mm Wire Tension Spring - 50mm Post	2
R4-ST5-25	Small Tension Spring - 25mm Post	2
R4-MSLD	Mini Slide Base	1
R4-ARP	Aluminum Resting Pin	4
R4-CV	Corner Viewer	1
R4-MCV	Mini Corner Viewer	1
R4-PC	Pusher Clamp	1
AX-BOX	Organizer Box	1
Total Components		49

Vacuum Clamping Kits: 1/4-20 Thread



Part Numbers	Description	R20-VCK-A	R20-VCK-B
R20-10-SC	10mm Suction Cup	3	3
R20-20-SC	20mm Suction Cup	4	4
R20-30-SC	30mm Suction Cup		2
R20-50-SC	50mm Suction Cup	1	1
R20-20-EXSC	20mm Exposed Suction Cup	2	2
R-9P-M	9-Port Manifold	1	1
R-VP	Vacuum Pump Assembly	1	1
R-12-VH	Vacuum Hose 12" Long	20	20
R-PMCD2202	Straight Hose Barb Connector	1	1
R-PMC23028	Elbow Connector	8	8
R20-37550-SO	3/8" Dia. x 1/2" Standoff	3	3
R20-5075-SO	1/2" Dia. X 3/4" Standoff		6
R20-501-SO	1/2" Dia. X 1" Standoff	4	6
R20-502-SO	1/2" Dia. X 2" Standoff		6
R20-7550-SO	3/4" Dia. X 1/2" Standoff	3	3
R20-7575-SO	3/4" Dia. X 3/4" Standoff		6
R20-751-SO	3/4" Dia. X 1" Standoff	4	6
R20-752-SO	3/4" Dia. X 2" Standoff	4	6
R20-753-SO	3/4" Dia. X 3" Standoff		3
R20-175-SO	1" Dia. X 3/4" Standoff	6	6
R20-11-SO	1" Dia. X 1" Standoff	4	6
R20-12-SO	1" Dia. X 2" Standoff	4	6
R20-14-SO	1" Dia. X 4" Standoff	3	3
R20-ST5-15	Small Tension Spring - 1.5" Post	4	4
R20-LTS-3	Large Tension Spring - 3" Post	4	8
R20-NC	Nylon Cone	4	4
R20-SRP	Steel Resting Pin	4	4
R20-50-JS	1/2" Dia. Jackstand		2
R20-1-JS	1" Dia. Jackstand	2	2
R20-MSLD	Mini Slide Base	2	2
R20-SLD	Slide Base	2	2
R20-LB	Locating Block with Base	2	2
R20-SCT	1/4-20 Small Component Tray	1	1
R-VCT	Vacuum Component Tray	1	1
Total Components		102	141

Vacuum Clamping Kits: M8 Thread



Part Numbers	Description	R8-VCK-A	R8-VCK-B
R8-10-SC	10mm Suction Cup	3	3
R8-20-SC	20mm Suction Cup	4	4
R8-30-SC	30mm Suction Cup	2	2
R8-50-SC	50mm Suction Cup	1	1
R8-20-EXSC	20mm Exposed Suction Cup	2	2
R-9P-M	9-Port Manifold	1	1
R-VP	Vacuum Pump Assembly	1	1
R-12-VH	Vacuum Hose 12" Long	20	20
R-PMCD2202	Straight Hose Barb Connector	1	1
R-PMC23028	Elbow Connector	8	11
R8-1320-SO	13mm Dia. X 20mm Standoff		6
R8-1325-SO	13mm Dia. X 25mm Standoff	6	6
R8-1350-SO	13mm Dia. X 50 mm Standoff	6	6
R8-1915-SO	19mm Dia. X 15mm Standoff	3	3
R8-1920-SO	19mm Dia. X 20mm Standoff		6
R8-1925-SO	19mm Dia. X 25mm Standoff	6	6
R20-1950-SO	19mm Dia. X 50mm Standoff		6
R8-1975-SO	19mm Dia. X 75mm Standoff	3	2
R8-2520-SO	25mm Dia. X 20mm Standoff		6
R8-2525-SO	25mm Dia. X 25mm Standoff	6	6
R8-2550-SO	25mm Dia. X 50mm Standoff		6
R8-25100-SO	25mm Dia. X 100mm Standoff		3
R8-STS-38	Small Tension Spring -38mm Post	4	4
R8-LTS-75	Large Tension Spring -75mm Post	8	8
R8-NC	Nylon Cone	4	4
R8-SC	Steel Cone	4	4
R8-19-JS	19mm Dia. Small Jackstand	2	2
R8-25-JS	25mm Dia. Large Jackstand		2
R8-SLD	Slide Base		3
R8-LB	Locating Block with Base		2
R8-SCT	M8 Small Component Tray	1	1
R-VCT	Vacuum Component Tray	1	1
Total Components		97	139

Vacuum Clamping Kits: M6 Thread



Part Numbers	Description	R6-VCK-A	R6-VCK-B
R6-10-SC	10mm Suction Cup	3	3
R6-20-SC	20mm Suction Cup	4	4
R6-30-SC	30mm Suction Cup		2
R6-50-SC	50mm Suction Cup	1	1
R6-20-EXSC	20mm Exposed Suction Cup	2	2
R-9P-M	9-Port Manifold	1	1
R-VP	Vacuum Pump Assembly	1	1
R-12-VH	Vacuum Hose 12" Long	20	20
R-PMCD2202	Straight Hose Barb Connector	8	8
R-PMC23028	Elbow Connector	1	1
R6-910-SO	9mm Dia. X 10mm Standoff	3	3
R6-1320-SO	13mm Dia. X 20mm Standoff		6
R6-1325-SO	13mm Dia. X 25mm Standoff	4	6
R6-1350-SO	13mm Dia. X 50mm Standoff		6
R6-1910-SO	19mm Dia. X 10mm Standoff	3	3
R6-1920-SO	19mm Dia. X 20mm Standoff		6
R6-1925-SO	19mm Dia. X 25mm Standoff	4	6
R6-1950-SO	19mm Dia. X 50mm Standoff	4	6
R6-19100-SO	19mm Dia. X 100mm Standoff		3
R6-2520-SO	25mm Dia. X 20mm Standoff	6	6
R6-2525-SO	25mm Dia. X 25mm Standoff	4	6
R6-2550-SO	25mm Dia. X 50mm Standoff	4	6
R6-25100-SO	25mm Dia. X 100mm Standoff	3	3
R6-ST3-38	Small Tension Spring - 38mm Post	4	4
R6-LTS-75	Large Tension Spring - 75mm Post	4	8
R6-NC	Nylon Cone	4	4
R6-SRP	Steel Resting Pin	4	4
R6-13-JS	13mm Dia. Small Jackstand		2
R6-25-JS	25mm Dia. Large Jackstand	2	2
R6-MSLD	Mini Slide Base	2	2
R6-SLD	Slide Base	2	2
R6-LB	Locating Block with Base	2	2
R6-SCT	M6 Small Component Tray	1	1
R-VCT	Vacuum Component Tray	1	1
Total Components		102	141

Vision Clamping Kits: 1/4-20 Thread



RA20-VK-A

Part Numbers	Description	RA20-VK-A	RA20-VK-B	RA20-VK-C
R20-2550-SO	1/4" Dia. X 1/2" Standoff	3	6	8
R20-251-SO	1/4" Dia. X 1" Standoff	3	6	8
R20-37525-SO	3/8" Dia. X 1/4" Standoff	3	3	8
R20-37550-SO	3/8" Dia. X 1/2" Standoff	3	6	8
R20-37575-SO	3/8" Dia. X 3/4" Standoff		6	8
R20-3751-SO	3/8" Dia. X 1" Standoff	3	6	6
R20-5050-SO	1/2" Dia. X 1/2" Standoff	3	6	6
R20-501-SO	1/2" Dia. X 1" Standoff		6	6
R20-2550-PSO	1/4" Dia. X 1/2" Pin Standoff	2	4	6
R20-37550-PSO	3/8" Dia. X 1/2" Pin Standoff	2	4	6
R20-501-PSO	1/2" Dia. X 1" Pin Standoff		4	4
R20-MTS-1	Mini Tension Spring - 1" Post	2	3	6
R20-MTS-2	Mini Tension Spring - 2" Post		3	6
R20-ST5-15	Small Tension Spring - 1.5" Post		6	6
R20-WTS-125-1	1.25" Wire Tension Spring - 1" Post	3	3	4
R20-WTS-2-2	2" Wire Tension Spring - 2" Post	3	3	4
R20-SRP	Steel Resting Pin	4	4	4
R20-CV	Corner Viewer		1	1
R20-MCV	Mini Corner Viewer	1		
R20-50-JS	1/2" Dia. Small Jackstand	1	2	2
R20-MSLD	Mini Slide Base	1	2	2
R20-PC	Pusher Clamp		1	1
R20-LB	Locating Block with Base	1		
R20-SCT	1/4-20 Small Component Tray		1	1
AX-BOX	Organizer Box	1		
Total Components		39	86	111

Vision Clamping Kits: M6 Thread



RA6-VK-C

Part Numbers	Description	RA6-VK-A	RA6-VK-B	RA6-VK-C
R6-610-SO	6mm Dia. X 10mm Standoff	3	6	8
R6-625-SO	6mm Dia. X 25mm Standoff	3	6	8
R6-95-SO	9mm Dia. X 5mm Standoff	3	3	8
R6-910-SO	9mm Dia. X 10mm Standoff	3	6	8
R6-920-SO	9mm Dia. X 20mm Standoff		6	8
R6-925-SO	9mm Dia. X 25mm Standoff	3	6	6
R6-1310-SO	13mm Dia. X 10mm Standoff	3	6	6
R6-1325-SO	13mm Dia. X 25mm Standoff		6	6
R6-610-PSO	6mm Dia. X 10mm Pin Standoff	2	4	6
R6-910-PSO	9mm Dia. X 10mm Pin Standoff	2	4	6
R6-1325-PSO	13mm Dia. X 25mm Pin Standoff		4	4
R6-MTS-25	Mini Tension Spring - 25mm Post	2	3	6
R6-MTS-50:	Mini Tension Spring - 50mm Post		3	6
R6-STS-38	Small Tension Spring - 38mm Post		6	6
R6-WTS-32-25	32mm Wire Tension Spring - 25mm Post	3	3	4
R6-WTS-50-50	50mm Wire Tension Spring - 50mm Post	3	3	4
R6-SRP	Steel Resting Pin	4	4	4
R6-CV	Corner Viewer	1	1	1
R6-13-JS	13mm Dia. Jackstand	1	2	2
R6-MSLD	Mini Slide Base	1	2	2
R6-LB	Locating Block with Base	1		
R6-PC	Pusher Clamp		1	1
R6-SCT	M6 Small Component Tray		1	1
AX-BOX	Organizer Box	1		
Total Components		39	86	111

Vision Clamping Kits: M4 Thread



Part Numbers	Description	RA4-VK-A	RA4-VK-B	RA4-VK-C
R4-65-SO	6mm Dia. X 5mm Standoff		3	6
R4-610-SO	6mm Dia. X 10mm Standoff	3	6	8
R4-625-SO	6mm Dia. X 25mm Standoff	3	6	8
R4-95-SO	9mm Dia. X 5mm Standoff	3	3	4
R4-910-SO	9mm Dia. X 10mm Standoff	3	6	8
R4-920-SO	9mm Dia. X 20mm Standoff		6	8
R4-925-SO	9mm Dia. X 25mm Standoff	3	6	8
R4-1210-SO	12mm Dia. X 10mm Standoff	3	6	8
R4-1225-SO	12mm Dia. X 25mm Standoff		6	8
R4-610-PSO	6mm Dia. X 10mm Pin Standoff	2	4	6
R4-910-PSO	9mm Dia. X 10mm Pin Standoff	2	4	6
R4-1210-PSO	12mm Dia. X 10mm Pin Standoff		4	6
R4-MTS-25	Mini Tension Spring - 25mm Post	3	4	8
R4-WTS-32-25	32mm Wire Tension Spring - 25mm Post	3	4	8
R4-WTS-50-50	50mm Wire Tension Spring - 50mm Post	2	4	8
R4-ST5-50	Small Tension Spring - 50mm Post	2	4	8
R4-MSLD	Mini Slide Base	1	2	2
R4-MJS	Mini JackStand	2	2	2
R4-ARP	Aluminum Resting Pin	4	4	6
R4-LB	Locating Block with Base		1	1
R4-MCV	Mini Corner Viewer	1	1	1
R4-PC	Pusher Clamp		1	2
R4-MCT	M4 Mini Component Tray		1	1
AX-BOX	Organizer Box	1		
Total Components		41	88	131

Small Tension Spring

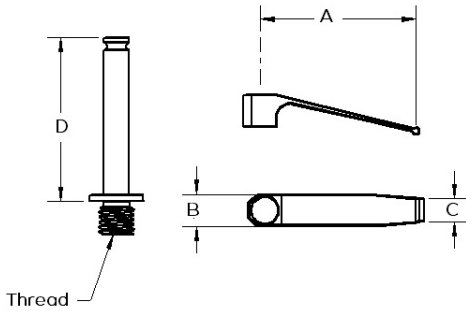

Part Number	Thread	A	B	C	D
R20-ST5-15	1/4-20	15"	0.3"	0.125"	15"
R20-ST5-3	1/4-20	15"	0.3"	0.125"	3"
R20-ST5-15-RT (Rubber Tipped)	1/4-20	15"	0.3"	0.125"	15"
R20-ST5-3-RT (Rubber Tipped)	1/4-20	15"	0.3"	0.125"	3"
R8-ST5-38	M8	38 mm	7.62 mm	3.29 mm	38 mm
R8-ST5-75	M8	38 mm	7.62 mm	3.29 mm	75 mm
R8-ST5-38-RT (Rubber Tipped)	M8	38 mm	7.62 mm	3.29 mm	38 mm
R8-ST5-75-RT (Rubber Tipped)	M8	38 mm	7.62 mm	3.29 mm	75 mm
R6-ST5-38	M6	38 mm	7.62 mm	3.29 mm	38 mm
R6-ST5-75	M6	38 mm	7.62 mm	3.29 mm	75 mm
R6-ST5-38-RT (Rubber Tipped)	M6	38 mm	7.62 mm	3.29 mm	38 mm
R6-ST5-75-RT (Rubber Tipped)	M6	38 mm	7.62 mm	3.29 mm	75 mm
R4-ST5-25	M4	38 mm	7.62 mm	3.29 mm	25 mm
R4-ST5-50	M4	38 mm	7.62 mm	3.29 mm	50 mm
R4-ST5-25-RT (Rubber Tipped)	M4	38 mm	7.62 mm	3.29 mm	25 mm
R4-ST5-50-RT (Rubber Tipped)	M4	38 mm	7.62 mm	3.29 mm	50 mm

Large Tension Spring

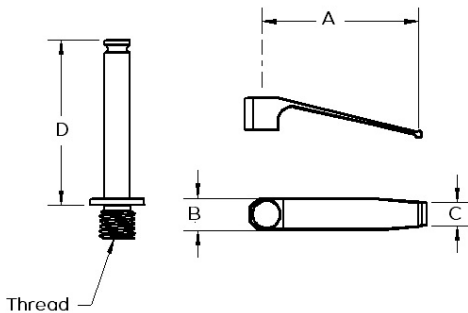

Part Number	Thread	A	B	C	D
R20-LTS-15	1/4-20	2.30"	0.5"	0.3"	15"
R20-LTS-3	1/4-20	2.30"	0.5"	0.3"	3"
R20-LTS-15-RT (Rubber Tipped)	1/4-20	2.30"	0.5"	0.3"	15"
R20-LTS-3-RT (Rubber Tipped)	1/4-20	2.30"	0.5"	0.3"	3"
R8-LTS-38	M8	58 mm	12.7 mm	6.5 mm	38 mm
R8-LTS-75	M8	58 mm	12.7 mm	6.5 mm	75 mm
R8-LTS-38-RT (Rubber Tipped)	M8	58 mm	12.7 mm	6.5 mm	38 mm
R8-LTS-75-RT (Rubber Tipped)	M8	58 mm	12.7 mm	6.5 mm	75 mm
R6-LTS-38	M6	58 mm	12.7 mm	6.5 mm	38 mm
R6-LTS-75	M6	58 mm	12.7 mm	6.5 mm	75 mm
R6-LTS-38-RT (Rubber Tipped)	M6	58 mm	12.7 mm	6.5 mm	38 mm
R6-LTS-75-RT (Rubber Tipped)	M6	58 mm	12.7 mm	6.5 mm	75 mm
R4-LTS-25	M4	58 mm	12.7 mm	6.5 mm	25 mm
R4-LTS-50	M4	58 mm	12.7 mm	6.5 mm	50 mm
R4-LTS-25-RT (Rubber Tipped)	M4	58 mm	12.7 mm	6.5 mm	25 mm
R4-LTS-50-RT (Rubber Tipped)	M4	58 mm	12.7 mm	6.5 mm	50 mm

Part Number	Thread	A	B	C	D
R20-XLTS	1/4-20	3.42"	0.75"	0.375"	3"
R20-XLTS-RT (Rubber Tipped)	1/4-20	3.42"	0.75"	0.375"	3"
R8-XLTS	M8	87 mm	19 mm	9.5 mm	76 mm
R20-XLTS-RT (Rubber Tipped)	M8	87 mm	19 mm	9.5 mm	76 mm
R6-XLTS	M6	87 mm	19 mm	9.5 mm	76 mm
R6-XLTS-RT (Rubber Tipped)	M6	87 mm	19 mm	9.5 mm	76 mm

X-Large Tension Spring

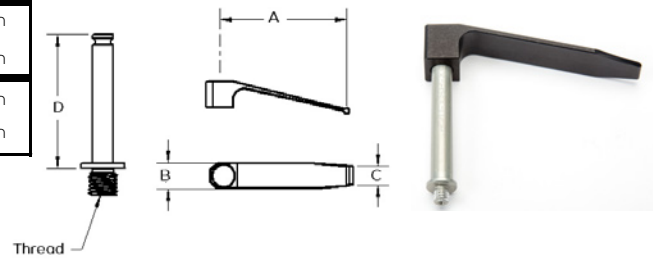

Part Number	Thread	A	B	C	D
R20-XLTSP	1/4-20	3.625"	0.75"	0.275"	3"
R8-XLTSP	M8	92 mm	19 mm	7 mm	76 mm
R6-XLTSP	M6	92 mm	19 mm	7 mm	76 mm

X-Large Tension Spring with Plunger

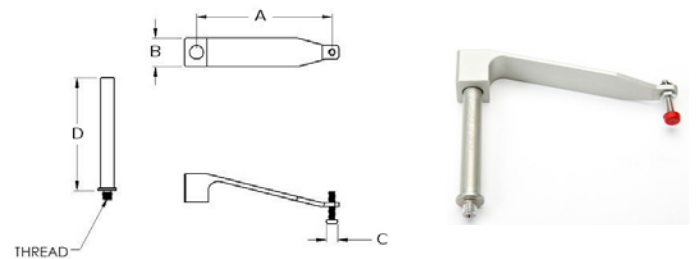

Part Number	Thread	A	B
R20-WTS-125-1	1/4-20	1.25"	1"
R20-WTS-2-2	1/4-20	2"	2"
R20-WTS-125-2	1/4-20	1.25"	2"
R20-WTS-2-1	1/4-20	2"	1"
R20-WTS-125-1-RT (Rubber Tipped)	1/4-20	1.25"	1"
R20-WTS-2-2-RT (Rubber Tipped)	1/4-20	2"	2"
R20-WTS-125-2-RT (Rubber Tipped)	1/4-20	1.25"	2"
R20-WTS-2-1-RT (Rubber Tipped)	1/4-20	2"	1"
R6-WTS-32-25	M6	32 mm	25 mm
R6-WTS-50-50	M6	50 mm	50 mm
R6-WTS-32-50	M6	32 mm	50 mm
R6-WTS-50-25	M6	50 mm	25 mm
R6-WTS-32-25-RT (Rubber Tipped)	M6	32 mm	25 mm
R6-WTS-50-50-RT (Rubber Tipped)	M6	50 mm	50 mm
R6-WTS-32-50-RT (Rubber Tipped)	M6	32 mm	50 mm
R6-WTS-50-25-RT (Rubber Tipped)	M6	50 mm	25 mm
R4-WTS-32-25	M4	32 mm	25 mm
R4-WTS-50-50	M4	50 mm	50 mm
R4-WTS-50-25	M4	50 mm	25 mm
R4-WTS-32-50	M4	32 mm	50 mm
R4-WTS-32-25-RT (Rubber Tipped)	M4	32 mm	25 mm
R4-WTS-50-50-RT (Rubber Tipped)	M4	50 mm	50 mm
R4-WTS-50-25-RT (Rubber Tipped)	M4	50 mm	25 mm
R4-WTS-32-50-RT (Rubber Tipped)	M4	32 mm	50 mm

Wire Tension Springs

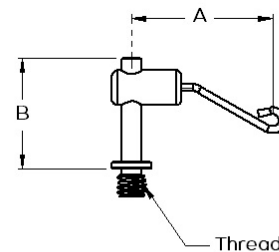

Mini Tension Springs

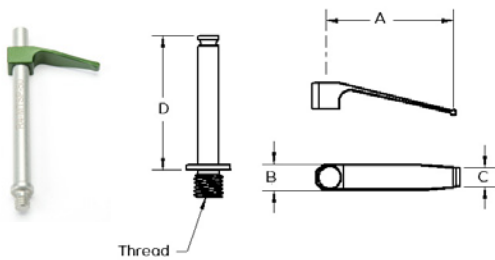

Part Number	Thread	A	B	C	D
R20-MTS-1	1/4-20	0.84"	0.25"	0.08"	1"
R20-MTS-2	1/4-20	0.84"	0.25"	0.08"	2"
R20-MTS-1-RT (Rubber Tipped)	1/4-20	0.84"	0.25"	0.08"	1"
R20-MTS-2-RT (Rubber Tipped)	1/4-20	0.84"	0.25"	0.08"	2"
R6-MTS-25	M6	21 mm	6.3 mm	2 mm	25 mm
R6-MTS-50	M6	21 mm	6.3 mm	2 mm	50 mm
R6-MTS-25-RT (Rubber Tipped)	M6	21 mm	6.3 mm	2 mm	25 mm
R6-MTS-50-RT (Rubber Tipped)	M6	21 mm	6.3 mm	2 mm	50 mm
R4-MTS-25	M4	21 mm	6.3 mm	2 mm	25 mm
R4-MTS-50	M4	21 mm	6.3 mm	2 mm	50 mm
R4-MTS-25-RT (Rubber Tipped)	M4	21 mm	6.3 mm	2 mm	25 mm
R4-MTS-50-RT (Rubber Tipped)	M4	21 mm	6.3 mm	2 mm	50 mm

Standoffs

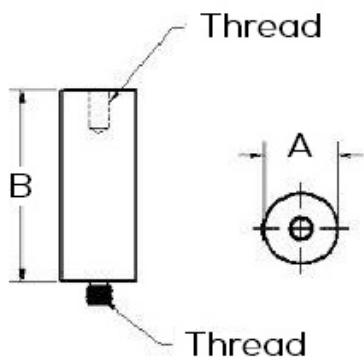

Part Number	Thread	A	B
R20-2525-SO (No female thread)	1/4-20	0.25"	0.25"
R20-2550-SO (No female thread)	1/4-20	0.25"	0.50"
R20-2575-SO (No female thread)	1/4-20	0.25"	0.75"
R20-251-SO (No female thread)	1/4-20	0.25"	1"
R20-37525-SO (No female thread)	1/4-20	0.375"	0.25"
R20-37550-SO	1/4-20	0.375"	0.50"
R20-37575-SO	1/4-20	0.375"	0.75"
R20-3751-SO	1/4-20	0.375"	1"
R20-5025-SO (No female thread)	1/4-20	0.50"	0.25"
R20-5050-SO	1/4-20	0.50"	0.50"
R20-5075-SO	1/4-20	0.50"	0.75"
R20-501-SO	1/4-20	0.50"	1"
R20-502-SO	1/4-20	0.50"	2"
R20-503-SO	1/4-20	0.50"	3"
R20-504-SO	1/4-20	0.50"	4"
R20-505-SO	1/4-20	0.50"	5"
R20-506-SO	1/4-20	0.50"	6"
R20-7550-SO	1/4-20	0.75"	0.50"
R20-7575-SO	1/4-20	0.75"	0.75"
R20-751-SO	1/4-20	0.75"	1"
R20-752-SO	1/4-20	0.75"	2"
R20-753-SO	1/4-20	0.75"	3"
R20-754-SO	1/4-20	0.75"	4"
R20-755-SO	1/4-20	0.75"	5"
R20-756-SO	1/4-20	0.75"	6"
R20-150-SO	1/4-20	1"	0.50"
R20-175-SO	1/4-20	1"	0.75"
R20-11-SO	1/4-20	1"	1"
R20-12-SO	1/4-20	1"	2"
R20-13-SO	1/4-20	1"	3"
R20-14-SO	1/4-20	1"	4"
R20-15-SO	1/4-20	1"	5"
R20-16-SO	1/4-20	1"	6"

Standoffs Continued

Part Number	Thread	A	B
R8-1315-SO	M8	13 mm	15 mm
R8-1320-SO	M8	13 mm	20 mm
R8-1325-SO	M8	13 mm	25 mm
R8-1350-SO	M8	13 mm	50 mm
R8-1375-SO	M8	13 mm	75 mm
R8-13100-SO	M8	13 mm	100 mm
R8-13150-SO	M8	13 mm	150 mm
R8-1915-SO	M8	19 mm	15 mm
R8-1920-SO	M8	19 mm	20 mm
R8-1925-SO	M8	19 mm	25 mm
R8-1950-SO	M8	19 mm	50 mm
R8-1975-SO	M8	19 mm	75 mm
R8-19100-SO	M8	19 mm	100 mm
R8-19150-SO	M8	19 mm	150 mm
R8-2515-SO	M8	25 mm	15 mm
R8-2520-SO	M8	25 mm	20 mm
R8-2525-SO	M8	25 mm	25 mm
R8-2550-SO	M8	25 mm	50 mm
R8-25100-SO	M8	25 mm	100 mm
R8-25150-SO	M8	25 mm	150 mm
R8-3825-SO	M8	38 mm	25 mm
R8-3850-SO	M8	38 mm	50 mm
R8-38150-SO	M8	38 mm	150 mm
R6-65-SO (No female thread)	M6	6 mm	5 mm
R6-610-SO (No female thread)	M6	6 mm	10 mm
R6-620-SO (No female thread)	M6	6 mm	20 mm
R6-625-SO (No female thread)	M6	6 mm	25 mm
R6-95-SO (No female thread)	M6	9 mm	5 mm
R6-910-SO	M6	9 mm	10 mm
R6-920-SO	M6	9 mm	20 mm
R6-925-SO	M6	9 mm	25 mm
R6-135-SO (No female thread)	M6	13 mm	5 mm
R6-1310-SO	M6	13 mm	10 mm
R6-1315-SO	M6	13 mm	15 mm
R6-1320-SO	M6	13 mm	20 mm
R6-1325-SO	M6	13 mm	25 mm
R6-1350-SO	M6	13 mm	50 mm
R6-1375-SO	M6	13 mm	75 mm
R6-13100-SO	M6	13 mm	100 mm
R6-13125-SO	M6	13 mm	125 mm
R6-13150-SO	M6	19 mm	150 mm
R6-1910-SO	M6	19 mm	10 mm
R6-1915-SO	M6	19 mm	15 mm
R6-1920-SO	M6	19 mm	20 mm
R6-1925-SO	M6	19 mm	25 mm
R6-1950-SO	M6	19 mm	50 mm
R6-1975-SO	M6	19 mm	75 mm
R6-19100-SO	M6	19 mm	100 mm
R6-19125-SO	M6	19 mm	125 mm

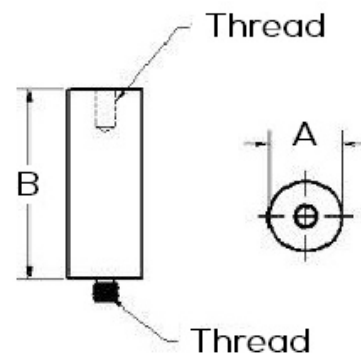

Standoffs Continued

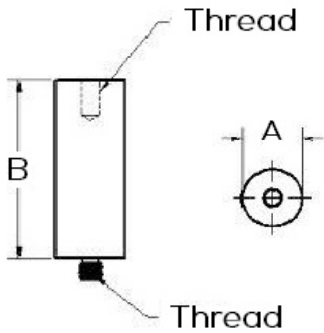

Part Number	Thread	A	B
R6-19150-SO	M6	19 mm	150 mm
R6-2520-SO	M6	25 mm	20 mm
R6-2525-SO	M6	25 mm	25 mm
R6-2550-SO	M6	25 mm	50 mm
R6-25100-SO	M6	25 mm	100 mm
R6-25125-SO	M6	25 mm	125 mm
R6-25150-SO	M6	25 mm	150 mm
R4-65-SO (No female thread)	M4	6 mm	5 mm
R4-610-SO (No female thread)	M4	6 mm	10 mm
R4-620-SO (No female thread)	M4	6 mm	20 mm
R4-625-SO (No female thread)	M4	6 mm	25 mm
R4-95-SO (No female thread)	M4	9 mm	5 mm
R4-910-SO	M4	9 mm	10 mm
R4-920-SO	M4	9 mm	20 mm
R4-925-SO	M4	9 mm	25 mm
R4-125-SO (No female thread)	M4	12 mm	5 mm
R4-1210-SO	M4	12 mm	10 mm
R4-1220-SO	M4	12 mm	20 mm
R4-1225-SO	M4	12 mm	25 mm

Pin Standoffs

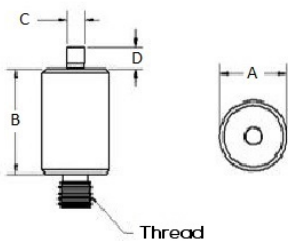

Part Number	Thread	A	B	C	D
R20-2525-PSO	1/4-20	0.25"	0.25"	0.062"	0.15"
R20-2550-PSO	1/4-20	0.25"	0.50"	0.062"	0.15"
R20-251-PSO	1/4-20	0.25"	1"	0.062"	0.15"
R20-37525-PSO	1/4-20	0.375"	0.25"	0.062"	0.15"
R20-37550-PSO	1/4-20	0.375"	0.50"	0.062"	0.15"
R20-3751-PSO	1/4-20	0.375"	1"	0.062"	0.15"
R20-5025-PSO	1/4-20	0.50"	0.25"	0.062"	0.15"
R20-5075-PSO	1/4-20	0.50"	0.75"	0.125"	0.15"
R20-501-PSO	1/4-20	0.50"	1"	0.125"	0.15"
R20-7575-PSO	1/4-20	0.75"	0.75"	0.125"	0.15"
R20-175-PSO	1/4-20	1"	0.75"	0.125"	0.15"
R20-11-PSO	1/4-20	1"	1"	0.125"	0.15"
R8-1320-PSO	M8	13 mm	20 mm	3.2 mm	3.8 mm
R8-1325-PSO	M8	13 mm	25 mm	3.2 mm	3.8 mm
R8-1920-PSO	M8	19 mm	20 mm	3.2 mm	3.8 mm
R6-1320-PSO	M6	13 mm	20 mm	3.2 mm	3.8 mm
R6-1325-PSO	M6	13 mm	25 mm	3.2 mm	3.8 mm
R6-1920-PSO	M6	19 mm	20 mm	3.2 mm	3.8 mm
R6-1925-PSO	M6	19 mm	25 mm	3.2 mm	3.8 mm
R6-65-PSO	M6	6 mm	5 mm	2 mm	3.8 mm
R6-610-PSO	M6	6 mm	10 mm	2 mm	3.8 mm
R6-625-PSO	M6	6 mm	25 mm	2 mm	3.8 mm
R6-95-PSO	M6	9 mm	5 mm	2 mm	3.8 mm
R6-910-PSO	M6	9 mm	10 mm	2 mm	3.8 mm
R6-925-PSO	M6	9 mm	25 mm	2 mm	3.8 mm

Part Number	Thread	A	B	C	D
R4-65-PSO	M4	6 mm	5 mm	2 mm	3.8 mm
R4-610-PSO	M4	6 mm	10 mm	2 mm	3.8 mm
R4-625-PSO	M4	6 mm	25 mm	2 mm	3.8 mm
R4-95-PSO	M4	9 mm	5 mm	2 mm	3.8 mm
R4-910-PSO	M4	9 mm	10 mm	2 mm	3.8 mm
R4-925-PSO	M4	9 mm	25 mm	2 mm	3.8 mm
R4-125-PSO	M4	12 mm	5 mm	2 mm	3.8 mm
R4-1210-PSO	M4	12 mm	10 mm	2 mm	3.8 mm
R4-1225-PSO	M4	12 mm	25 mm	2 mm	3.8 mm

Pin Standoffs Continued



Part Number	Thread	A	B	C	D
R20-502-SLTP	1/4-20	2"	0.50" Dia.	0.250" Dia.	0.045" Rad.
R20-752-SLTP	1/4-20	2"	0.75" Dia.	0.375" Dia.	0.125" Rad.
R8-1350-SLTP	M8	50 mm	13 mm Dia.	6 mm Dia.	1 mm Rad.
R8-1950-SLTP	M8	50 mm	19 mm Dia.	9 mm Dia.	3mm Rad.
R6-1950-SLTP	M6	50 mm	19 mm Dia.	9 mm Dia.	3mm Rad.
R6-2550-SLTP	M6	50 mm	25 mm Dia.	16 mm Dia.	6mm Rad.

Spring Loaded Tapered Pin Standoffs

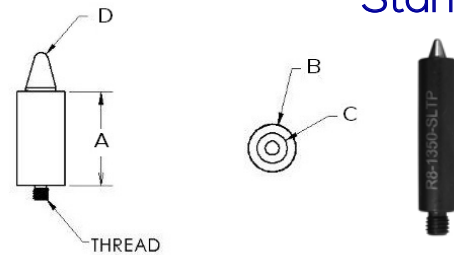

Part Number	Thread	A	B	C
R20-5075-RPSO	1/4-20	0.75"	0.50" Dia.	0.250" Dia.
R20-501-RPSO	1/4-20	1"	0.50" Dia.	0.250" Dia.
R8-1320-RPSO	M8	20 mm	13 mm Dia.	6.3 mm Dia.
R8-1325-RPSO	M8	25 mm	13 mm Dia.	6.3mm Dia.
R6-1320-RPSO	M6	20 mm	13 mm Dia.	6.3 mm Dia.
R6-1325-RPSO	M6	25 mm	13 mm Dia.	6.3 mm Dia.

Rounded Pin Standoffs

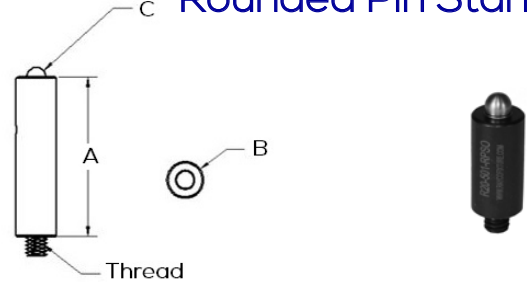

Part Number	Thread	A	B	C
R20-502-SLRP	1/4-20	2"	0.50" Dia.	0.250" Dia.
R20-752-SLRP	1/4-20	2"	0.75" Dia.	0.375" Dia.
R8-1350-SLRP	M8	50 mm	13 mm Dia.	6.3 mm Dia.
R8-1950-SLRP	M8	50 mm	19 mm Dia.	9.5 mm Dia.
R6-1350-SLRP	M6	50 mm	13 mm Dia.	6.3 mm Dia.
R6-1950-SLRP	M6	50 mm	19 mm Dia.	9.5 mm Dia.

Spring Loaded Rounded Pin Standoffs

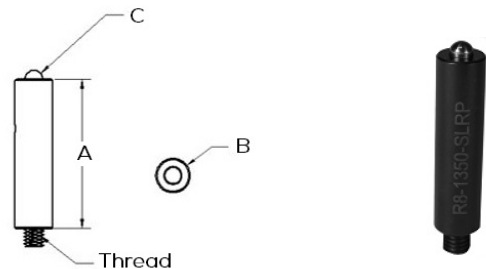

Part Number	Thread	A	B	C	D
R20-5050-SPS	1/4-20	0.50"	0.50"	0.069"	0.008"
R20-751-SPS	1/4-20	0.75"	1"	0.168"	0.027"
R8-1925-SPS	M8	19 mm	25 mm	4.3 mm	0.7 mm
R6-1310-SPS	M6	10 mm	10 mm	1.8 mm	0.2 mm
R6-1925-SPS	M6	19 mm	25 mm	4.3 mm	0.2 mm
R4-1210-SPS	M4	12 mm	10 mm	1.8 mm	0.2 mm

Spring Locating Pin Standoffs

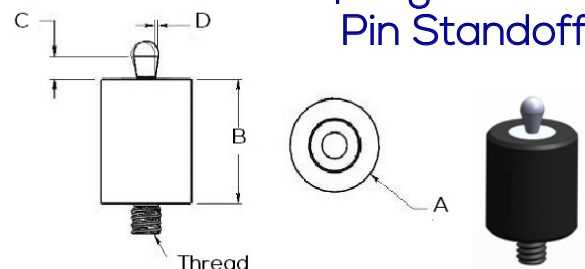

*Optional pin material and side forces available

Rotational Spring Locating Pin Standoff

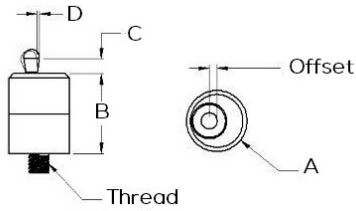

Part Number	Thread	A	B	C	D
R20-75-CSPS	1/4-20	0.75"	1"	0.168"	0.027"
R8-19-CSPS	M8	19 mm	25 mm	4.3 mm	0.7 mm
R6-19-CSPS	M6	19 mm	25 mm	4.3 mm	0.7 mm
R4-19-CSPS	M4	19 mm	25 mm	4.3 mm	0.7 mm

*Optional pin material and side forces available

Magnetic Standoffs

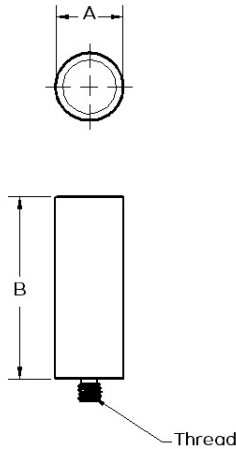

Part Number	Thread	A	B
R20-50-M	1/4-20	0.50"	1"
R20-75-M	1/4-20	0.75"	1"
R20-1-M	1/4-20	1"	1"
R20-125-M	1/4-20	1.25"	1"
R8-13-M	M8	13 mm	25 mm
R8-19-M	M8	19 mm	25 mm
R8-25-M	M8	25 mm	25 mm
R8-32-M	M8	32 mm	25 mm
R6-13-M	M6	13 mm	25 mm
R6-19-M	M6	19 mm	25 mm
R6-25-M	M6	25 mm	25 mm
R4-6-M	M4	6 mm	25 mm
R4-13-M	M4	13 mm	25 mm

Magnetic Pin Standoffs

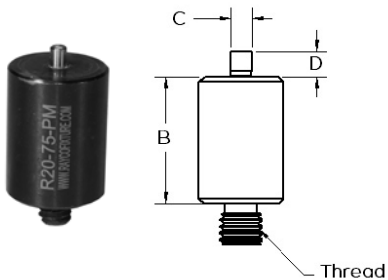

Part Number	Thread	A	B	C	D
R20-50-PM	1/4-20	0.50"	1"	0.125"	0.150"
R20-75-PM	1/4-20	0.75"	1"	0.125"	0.150"
R20-1-PM	1/4-20	1"	1"	0.125"	0.150"
R8-13-PM	M8	13 mm	25 mm	3 mm	3.8 mm
R8-19-PM	M8	19 mm	25 mm	3 mm	3.8 mm
R8-25-PM	M8	25 mm	25 mm	3 mm	3.8 mm
R6-13-PM	M6	13 mm	25 mm	3 mm	3.8 mm
R6-19-PM	M6	19 mm	25 mm	3 mm	3.8 mm
R6-25-PM	M6	25 mm	25 mm	3 mm	3.8 mm
R4-6-PM	M4	6 mm	25 mm	2 mm	3.8 mm
R4-13-PM	M4	13 mm	25 mm	2 mm	3.8 mm

Part Number	Thread	A	B	C	D
R20-50-VMB	1/4-20	0.50"	3"	1"	1.50"
R20-75-VMB	1/4-20	0.75"	3"	1"	1.50"
R20-1-VMB	1/4-20	1"	3"	1"	1.50"
R20-125-VMB	1/4-20	1.25"	3"	1"	1.50"
R8-13-VMB	M8	13 mm	75 mm	25 mm	36 mm
R8-19-VMB	M8	19 mm	75 mm	25 mm	36 mm
R8-25-VMB	M8	25 mm	75 mm	25 mm	36 mm
R8-32-VMB	M8	32 mm	75 mm	25 mm	36 mm
R6-13-VMB	M6	13 mm	75 mm	25 mm	36 mm
R6-19-VMB	M6	19 mm	75 mm	25 mm	36 mm
R6-25-VMB	M6	25 mm	75 mm	25 mm	36 mm

V-Magnets with Base

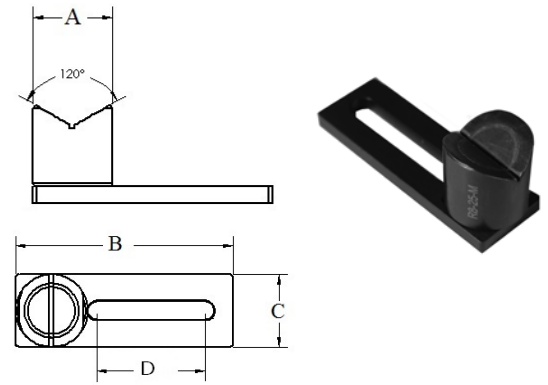

Part Number	Thread	A	B
R20-50-VM	1/4-20	0.50"	1"
R20-75-VM	1/4-20	0.75"	1"
R20-1-VM	1/4-20	1"	1"
R20-125-VM	1/4-20	1.25"	1"
R8-13-VM	M8	13 mm	25 mm
R8-19-VM	M8	19 mm	25 mm
R8-25-VM	M8	25 mm	25 mm
R8-32-VM	M8	32 mm	25 mm
R6-13-VM	M6	13 mm	25 mm
R6-19-VM	M6	19 mm	25 mm
R6-25-VM	M6	25 mm	25 mm

V-Magnets

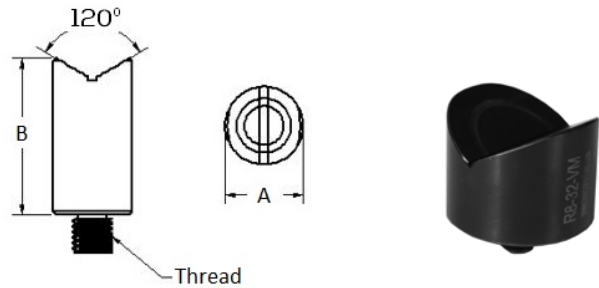

Part Number	Thread	A	B	C
R20-11-RS	1/4-20	1"	0.50"	1"
R6-2525-RS	M6	25 mm	13 mm	25 mm

Rotating Standoffs*

* Used for holding parts against stop

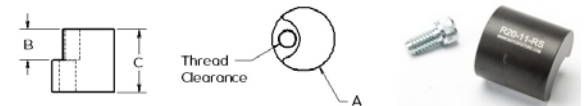

Part Number	Thread 1	A	B	Thread 2
R20-6-SOA	1/4-20	1"	1"	M6
R20-8-SOA	1/4-20	1"	1"	M8
R20-10-SOA	1/4-20	1"	1"	M10
R20-12-SOA	1/4-20	1"	1"	M12
R20-516-SOA	1/4-20	1"	1"	5/16-18
R20-38-SOA	1/4-20	1"	1"	3/8-16
R8-14-SOA	M8	25 mm	25 mm	1/4-20
R6-20-SOA	M6	25 mm	25 mm	1/4-20
R6-8-SOA	M6	25 mm	25 mm	M8
R4-14-SOA	M4	19 mm	15 mm	1/4-20

Standoff Adapters

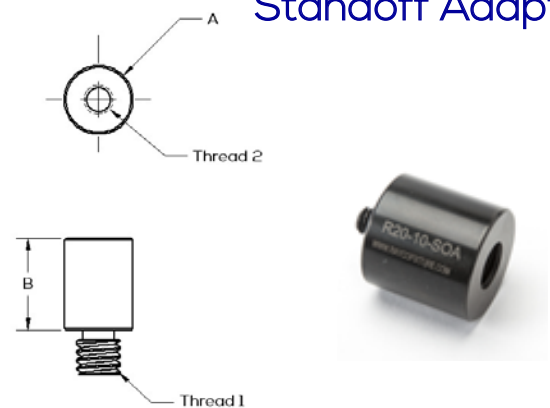

Adjustable Height Stands

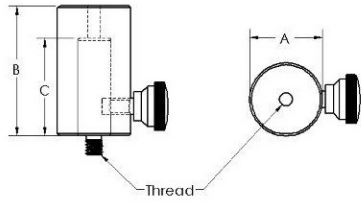

Part Number	Thread	A	B	C
R20-AHS	1/4-20	1.125"	2"	1.5"
R8-AHS	M8	28.5 mm	50 mm	38 mm
R6-AHS	M6	28.5 mm	50 mm	38mm

Adjustable V-Height Stands

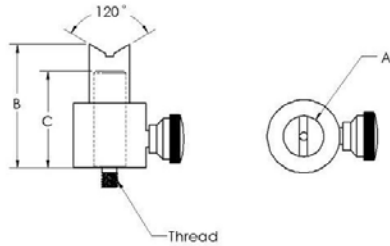

Part Number	Thread	A	B	C
R20-50-AHVS	1/4-20	0.625"	1.9"	1.5"
R20-1-AHVS	1/4-20	1.125"	2"	1.5"
R8-12-AHVS	M8	16 mm	48.5 mm	38 mm
R8-25-AHVS	M8	25 mm	50 mm	38 mm
R6-12-AHVS	M6	16 mm	48.5 mm	38 mm
R6-25-AHVS	M6	25 mm	50 mm	38 mm

Adjustable T-Arms

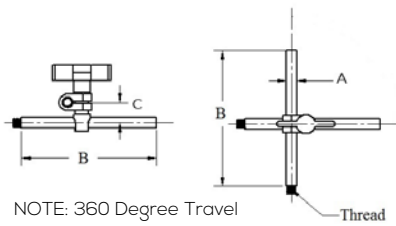

NOTE: 360 Degree Travel

Part Number	Thread	A	B	C
R20-AA	1/4-20	0.3125"	4"	0.6"
R8-AA	M8	8 mm	100 mm	15 mm
R6-AA	M6	8 mm	100 mm	15 mm

Resting Pins

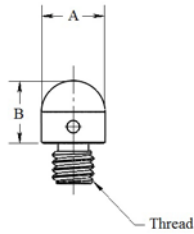

Part Number	Thread	A	B	Material
R20-SRP	1/4-20	0.375"	0.375"	Steel
R8-SRP	M8	13 mm	12 mm	Steel
R6-SRP	M6	9.5 mm	9.5 mm	Steel
R4-ARP	M4	6.3 mm	5 mm	Aluminum

Cones

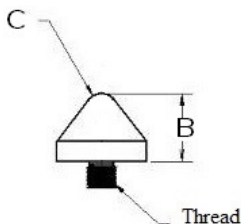
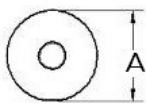

Part Number	Thread	A	B	C	Material
R20-NC	1/4-20	0.625"	0.50"	0.156"	Nylon
R20-SC	1/4-20	0.625"	0.50"	0.156"	Steel
R20-AC	1/4-20	1"	0.75"	0.1875"	Aluminum
R8-NC	M8	16 mm	13 mm	4 mm	Nylon
R8-NC-L	M8	25 mm	19 mm	4.8 mm	Nylon
R8-SC	M8	16 mm	13 mm	4 mm	Steel
R8-AC	M8	25 mm	19 mm	4.8 mm	Aluminum
R6-NC	M6	16 mm	13 mm	4 mm	Nylon
R6-NC-L	M6	25 mm	19 mm	4.8 mm	Nylon
R6-SC	M6	16 mm	13 mm	4 mm	Steel
R6-AC	M6	25 mm	19 mm	4.8 mm	Aluminum

Tension Spring Brackets

Part Number	Thread	A	B	C	D
R20-75-TSB	1/4-20	0.75"	1.40"	2.240"	3.110"
R20-1-TSB	1/4-20	1"	1.40"	2.240"	3.235"
R8-19-TSB	M8	19 mm	35.6 mm	56.9 mm	79 mm
R8-25-TSB	M8	25 mm	35.6 mm	56.9 mm	82.2 mm
R6-19-TSB	M6	19 mm	35.6 mm	56.9 mm	79 mm
R6-25-TSB	M6	25 mm	35.6 mm	56.9 mm	82.2 mm

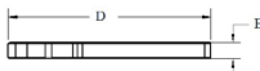
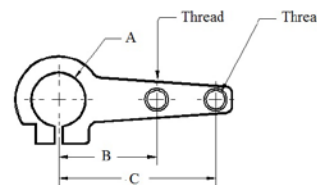

Part Number	Thread	A	B	C	D
R20-CTB-1	1/4-20	3.375"	1.273"	1"	1.19"
R8-CTB-25	M8	86 mm	32 mm	25 mm	30 mm
R6-CTB-25	M6	86 mm	32 mm	25 mm	30 mm

Adjustable Tension Spring Bracket

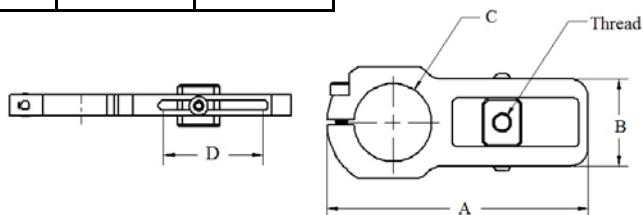

Part Number	Thread	A	B	C	D	Material
R20-SLD	1/4-20	3"	1"	1.545"	0.250"	Steel
R20-MSLD	1/4-20	1.375"	0.626"	0.563"	0.250"	Aluminum
R20-ASLD	1/4-20	2"	0.625"	1.25"	0.250"	Acrylic
R8-SLD	M8	65 mm	20 mm	32 mm	10 mm	Steel
R6-SLD	M6	75 mm	25 mm	40 mm	6.35 mm	Steel
R6-MSLD	M6	35 mm	16 mm	15 mm	6.35 mm	Aluminum
R6-ASLD	M6	50 mm	15.9 mm	31.8 mm	6 mm	Acrylic
R4-MSLD	M4	30 mm	12 mm	11 mm	5 mm	Aluminum
R4-ASLD	M4	38.1 mm	12.7 mm	20.6 mm	5 mm	Acrylic

Slide Bases

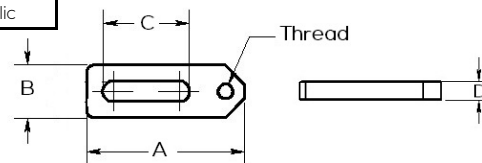

Part Number	Thread	A	B	C
R20-LB	1/4-20	0.75"	2.625"	1.25"
R20-LB-B (Base)	1/4-20	0.75"	2.625"	n/a
R8-LB	M8	25 mm	85 mm	40 mm
R8-LB-B (Base)	M8	25 mm	85 mm	n/a
R6-LB	M6	19 mm	66.7 mm	32 mm
R6-LB-B (Base)	M6	19 mm	66.7 mm	n/a
R4-LB	M4	16 mm	42 mm	24 mm
R4-LB-B (Base)	M4	16 mm	42 mm	n/a

Locating Blocks

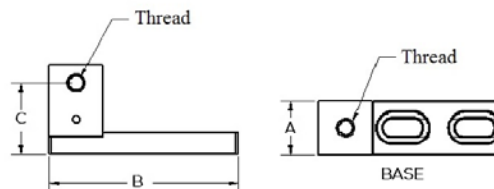

Spring Holding Devices

Part Number	Thread	A	B	C	D
R20-SHD	1/4-20	0.5"	1"	1.75"	1.74"
R8-SHD	M8	13 mm	25 mm	44 mm	44 mm
R6-SHD	M6	13 mm	25 mm	44 mm	44 mm

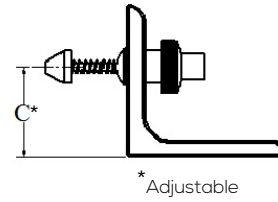
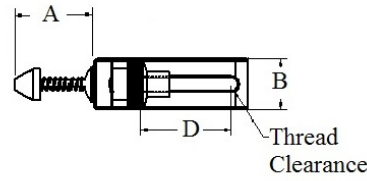

Pusher Clamp

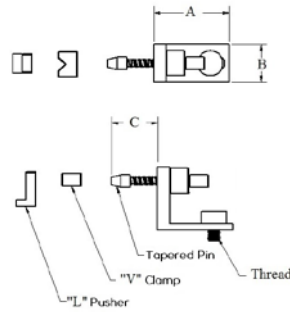

Part Number	Thread	A	B	C
R20-PC	1/4-20	1.5"	0.75"	0.15"
R6-PC	M6	38 mm	19 mm	3.8 mm
R4-PC	M4	38 mm	19 mm	3.8 mm

Spring Loaded Pusher Clamp

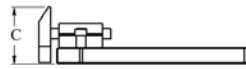
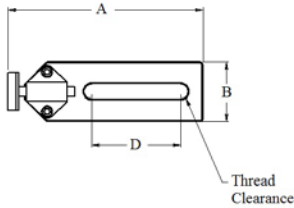

Part Number	Thread	A	B	C	D
R20-SLPC	1/4-20	3.25"	1"	0.90"	1.75"
R8-SLPC	M8	83 mm	25 mm	22.8 mm	44 mm
R6-SLPC	M6	83 mm	25 mm	22.8 mm	44 mm

Adjustable Jackstands

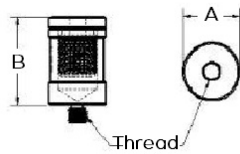

Part Number	Thread	A	B	Height Adjustment
R20-50-JS	1/4-20	0.625"	15"	0.500"
R20-1-JS	1/4-20	1"	15"	0.500"
R8-19-JS	M8	19 mm	38 mm	13 mm
R8-25-JS	M8	25 mm	38 mm	13 mm
R6-13-JS	M6	13 mm	38 mm	13 mm
R6-25-JS	M6	25 mm	38 mm	13 mm
R4-MJS	M4	9.5 mm	20.2 mm	5 mm

Tooling Balls

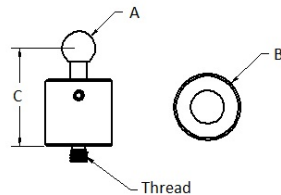

Part Number	Thread	A	B	C
R20-50-TB	1/4-20	0.5"	1"	1.5"
R8-12-TB	M8	12.7 mm	25 mm	38.1 mm
R6-12-TB	M6	12.7 mm	25 mm	38.1 mm

Part Number	Thread	A	B	C	D
R20-SDC	1/4-20	3.6"	0.15"	1"	0.6"
R20-LDC	1/4-20	5.030"	0.48"	15"	2.03"
R8-SDC	M8	25.4 mm	3.8 mm	25.4 mm	15.2 mm
R8-LDC	M8	127.8 mm	12.2 mm	38.1 mm	51.6 mm
R6-SDC	M6	91.4 mm	3.8 mm	25.4 mm	15.2 mm
R6-LDC	M6	127.8 mm	12.2 mm	38.1 mm	51.6 mm

Hold Down Clamps

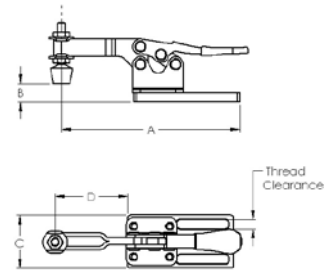

Part Number	Thread	A	B	C
R20-CJ3	1/4-20	5"	7"	3.75"
R8-CJ3	M8	127 mm	177.8 mm	95 mm
R6-CJ3	M6	127 mm	177.8 mm	95 mm

3 Jaw Chucks

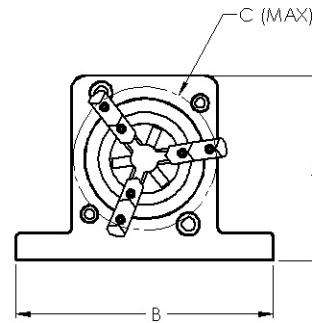
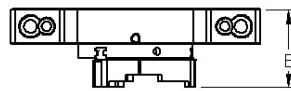

Part Number	Thread	A	B	C	D
R20-CJ3-R	1/4-20	4"	2.727"	15"	2.32"
R8-CJ3-R	M8	101.6 mm	69.27 mm	38.1 mm	59 mm
R6-CJ3-R	M6	101.6 mm	69.27 mm	38.1 mm	59 mm

Rotational 3 Jaw Chucks

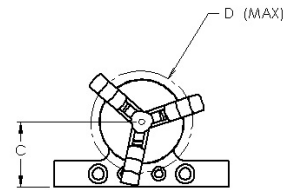
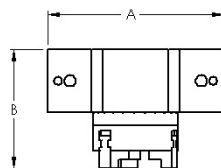

Part Number	Thread	A	B	C	Max Opening
R20-MV-2125	1/4-20	2.4"	4.40"	1.75"	2.2"
R8-MV-2125	M8	61 mm	111.75 mm	44 mm	55.90 mm
R6-MV-2125	M6	61 mm	111.75 mm	44 mm	55.90 mm

Vices

*Optional Rotational Base Available

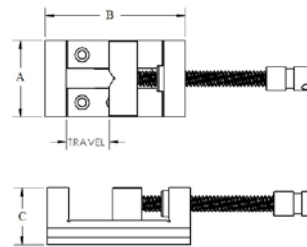

Part Number	A	B	C	Max Opening
R-MV-A	0.625"	1.69"	1.6"	0.84"
R-MV-B	0.625"	2"	1.78"	0.84"

Offered in 1/4-20, M6 and M4 thread

Mini Vices

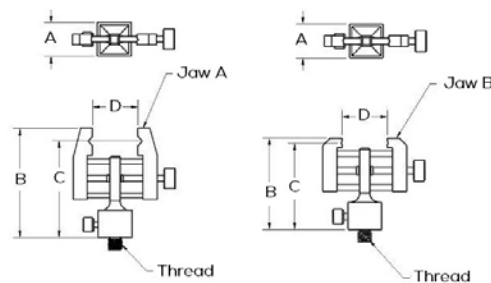

Small Vice Clamp

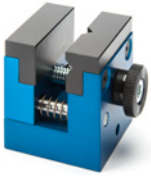

*Standard SVC is supplied with plastic jaws as show

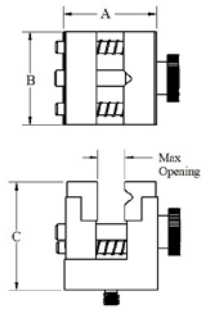

Part Number	Thread	A	B	C	Max Opening
R20-SVC	1/4-20	15"	15"	1.75"	0.45"
R8-SVC	M8	38 mm	38 mm	44.5 mm	11 mm
R6-SVC	M6	38 mm	38 mm	44.5 mm	11 mm
R4-SVC	M4	38 mm	38 mm	44.5 mm	11 mm

*Jaw Material: Plastic, Aluminum and Steel

*Jaw Design: Horizontal or Vertical V-notch

Stepped (to control seated depth of clamp part)

90 Degree Angle Brackets

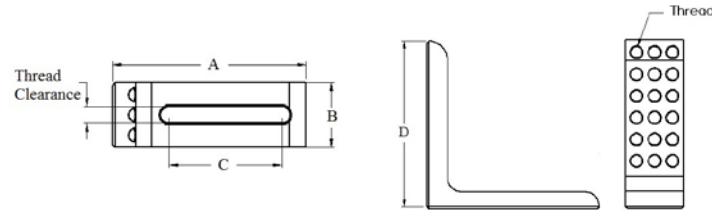

Part Number	Thread	A	B	C	D
R20-90L2 (2 rows)	1/4-20	3"	1"	1.75"	3"
R20-90L3 (3 rows)	1/4-20	3"	1"	1.75"	3"
R8-90L2 (2 rows)	M8	76 mm	25mm	44.45 mm	76.2 mm
R6-90L2 (2 rows)	M6	76 mm	25 mm	44.45 mm	76.2 mm
R6-90L3 (3 rows)	M6	76 mm	25 mm	44.45 mm	76.2 mm
R4-90L4 (4 rows)	M4	76 mm	25 mm	44.45 mm	76.2 mm

Vertical Plates



Numbers in the X-Axis & Letters in the Z-Axis.

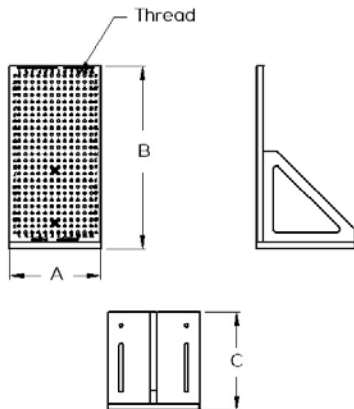

Part Number	Thread	A	B	C
R20-3250-50-VP	1/4-20	3"	2"	2"
R20-125-VP	1/4-20	12"	5"	6"
R20-147-VP	1/4-20	14"	7"	7.5"
R20-2010-VP	1/4-20	20"	10"	8"
R8-300125-VP	M8	300 mm	125 mm	127 mm
R8-350180-VP	M8	350 mm	180 mm	180 mm
R8-500250-VP	M8	500 mm	250 mm	203 mm
R8-755013-10-VP	M8	75 mm	50 mm	50 mm
R6-300125-VP	M6	300 mm	125 mm	127 mm
R6-350180-VP	M6	350 mm	180 mm	180 mm
R6-500250-VP	M6	500 mm	250 mm	203 mm
R6-755013-10-VP	M6	75 mm	50 mm	50 mm
R4-507513-10-VP	M4	50 mm	75 mm	38 mm

Adjustable Angle Plate

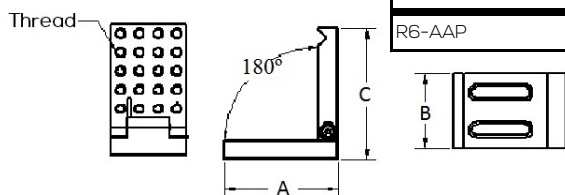

Part Number	Thread	A	B	C
R20-AAP	1/4-20	3"	2"	3.5"
R8-AAP	M8	75 mm	50 mm	88.9 mm
R6-AAP	M6	75 mm	50 mm	88.9 mm

Part Number	Thread	A	B	C
R20-16-MT4	1/4-20	6"	1" sq.	5"
R20-112-MT4	1/4-20	12"	1" sq.	5"
R20-1512-MT4	1/4-20	12"	1.5" sq.	6"
R20-1518-MT4	1/4-20	18"	1.5" sq.	6"
R20-224-MT4	1/4-20	24"	2" sq.	6"
R20-230-MT4	1/4-20	30"	2" sq.	6"
R8-25150-MT4	M8	150 mm	25 mm sq.	127 mm
R8-25300-MT4	M8	300 mm	25 mm sq.	127 mm
R8-38300-MT4	M8	300 mm	38 mm sq.	152.4 mm
R8-38450-MT4	M8	450 mm	38 mm sq.	152.4 mm
R8-50600-MT4	M8	600 mm	50 mm sq.	152.4 mm
R8-50750-MT4	M8	750 mm	50 mm sq.	152.4 mm
R6-25150-MT4	M6	150 mm	25 mm sq.	127 mm
R6-25300-MT4	M6	300 mm	25 mm sq.	127 mm

Mini Towers

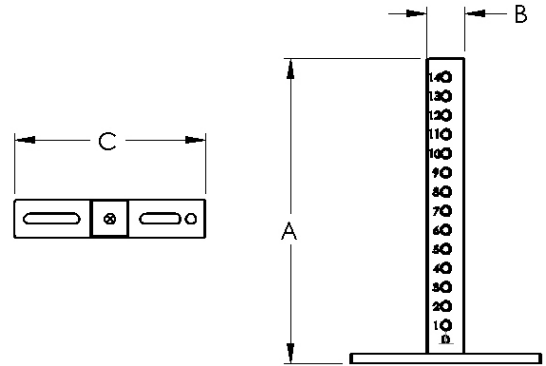

Part Number	Thread	A	B	C	D
R20-MCV	1/4-20	1.75"	0.5"	1.75"	0.25"
R20-CV	1/4-20	3.25"	0.75"	3.25"	0.25"
R8-MCV	M8	50 mm	19 mm	50 mm	9.5 mm
R8-CV	M8	82.5 mm	19 mm	82.5 mm	9.5 mm
R6-MCV	M6	44.43 mm	12.7 mm	44.43 mm	6.30 mm
R6-CV	M6	75.2 mm	19 mm	75.2 mm	6.30 mm
R4-MCV	M4	30 mm	10 mm	30 mm	5 mm
R4-CV	M4	50 mm	10 mm	50 mm	5 mm

Corner Viewer

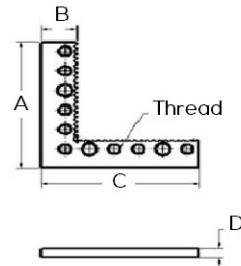

Part Number	Thread	A	B
R20-PJ	1/4-20	1125"	150"
R8-PJ	M8	28.60 mm	38.1 mm
R6-PJ	M6	28.60 mm	38.1 mm

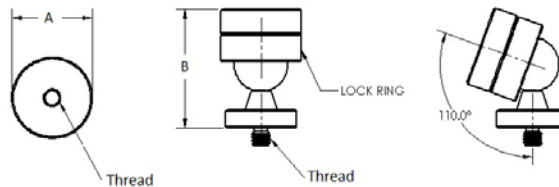

Pivot Joints



Part Number	Thread	A	B
R20-APJ	1/4-20	0.75"	1.70"
R8-APJ	M8	19 mm	43.2 mm
R6-APJ	M6	19 mm	43.2 mm

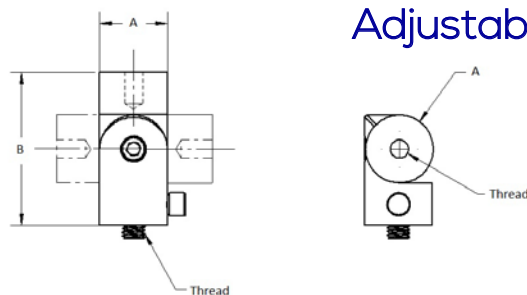

Adjustable Pivot Joints



Acrylic V-Blocks



Part Number	Thread	A	B	C	D
RA20-5-V	1/4-20	2"	1"	0.75" REF.	0.5"
RA6-13-V	M6	50 mm	25 mm	19 mm REF.	13 mm
RA4-6-V	M4	50 mm	25 mm	19 mm REF.	16 mm
RA4-13-V	M4	50 mm	25 mm	19 mm REF.	13 mm

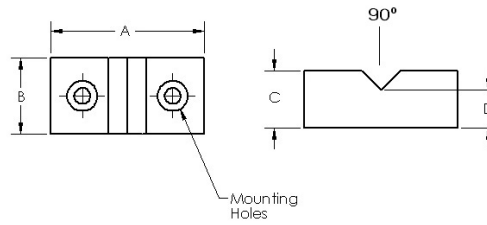

Slide Base with Mirror

Part Number	Thread	A	B	C	D
R20-SLDM	1/4-20	3"	0.8"	1.375"	0.99"
R6-SLDM	M6	75 mm	20.3 mm	35 mm	25.2 mm
R4-SLDM	M4	75 mm	20.3 mm	35 mm	25.2 mm

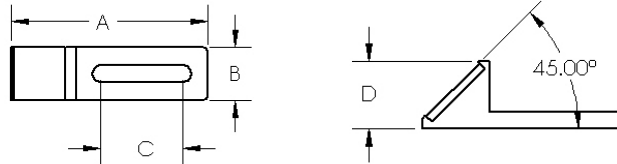
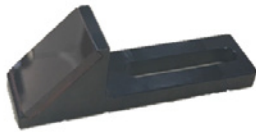

Male Centers

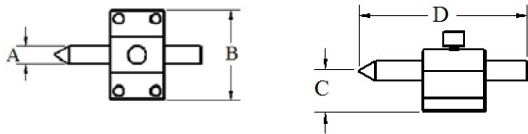

Part Number	Thread	A	B	C	D
R20-25-C	1/4-20	0.25"	2"	0.875"	2"
R20-50-C	1/4-20	0.5"	2.5"	1"	4"
R20-1-C	1/4-20	1"	2.5"	1"	4"
R8-6-C	M8	6.35 mm	50.8 mm	22.2 mm	50 mm
R8-13-C	M8	12.7 mm	63.5 mm	25.4 mm	101.6 mm
R8-25-C	M8	25.4 mm	63.5 mm	25.4 mm	101.6 mm
R6-6-C	M6	6.35 mm	50.8 mm	22.2 mm	50 mm
R6-13-C	M6	12.7 mm	63.5 mm	25.4 mm	101.6 mm
R6-25-C	M6	25.4 mm	63.5 mm	25.4 mm	101.6 mm

Mini Male Center

Part Number	Thread	A	B	C	D
R4-MC	M4	32 mm	50 mm	8 mm	33 mm

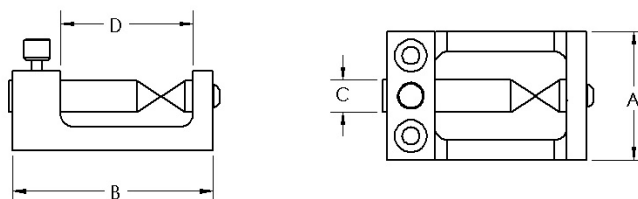

Part Number	Thread	A	B	C
R20-5-MS	1/4-20	5 mm	0.438"	1.378"
R20-10-SC	1/4-20	10 mm	0.63"	1.75"
R20-15-SC	1/4-20	15 mm	0.875"	1.75"
R20-20-SC	1/4-20	20 mm	1.125"	1.75"
R20-30-SC	1/4-20	30 mm	1.6"	2.5"
R20-50-SC	1/4-20	50 mm	2.5"	2.5"
R8-10-SC	M8	10 mm	16 mm	44.5 mm
R8-15-SC	M8	15 mm	22.2 mm	44.5 mm
R8-20-SC	M8	20 mm	28.6 mm	44.5 mm
R8-30-SC	M8	30 mm	41.7 mm	63.5 mm
R8-50-SC	M8	50 mm	64 mm	63.5 mm
R6-5-SC	M6	5 mm	11.3 mm	35 mm
R6-10-SC	M6	10 mm	16 mm	44.5 mm
R6-15-SC	M6	15 mm	22.2 mm	44.5 mm
R6-20-SC	M6	20 mm	28.6 mm	44.5 mm
R6-30-SC	M6	30 mm	41.7 mm	63.5 mm
R6-50-SC	M6	50 mm	64 mm	63.5 mm
R4-5-SC	M4	5 mm	11.3 mm	35 mm
R4-10-SC	M4	10 mm	16 mm	44.5 mm
R4-15-SC	M4	15 mm	22.2 mm	44.5 mm
R4-20-SC	M4	20 mm	28.6 mm	44.5 mm

Suction Cups with Housing

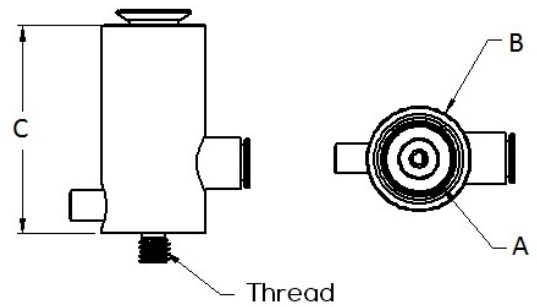

Part Number	Thread	A	B	C	Inc. Angle
R20-5-VSC	1/4-20	5 mm	0.438"	1.46"	90°
R20-10-VSC	1/4-20	10 mm	0.75"	1.875"	120°
R20-15-VSC	1/4-20	15 mm	1"	1.95"	120°
R20-20-VSC	1/4-20	20 mm	1.25"	2"	120°
R20-30-VSC	1/4-20	30 mm	1.75"	2.75"	120°
R20-50-VSC	1/4-20	50 mm	1.75"	3"	120°
R8-10-VSC	M8	10 mm	19 mm	50.8 mm	120°
R8-20-VSC	M8	20 mm	31.8 mm	50.8 mm	120°
R8-30-VSC	M8	30 mm	44.5 mm	75 mm	120°
R8-50-VSC	M8	50 mm	44.5 mm	75 mm	120°
R6-5-VSC	M6	5 mm	11.1 mm	37 mm	90°
R6-10-VSC	M6	10 mm	19 mm	37 mm	120°
R6-15-VSC	M6	15 mm	23.8 mm	50.8 mm	120°
R6-20-VSC	M6	20 mm	31.8 mm	50.8 mm	120°
R6-30-VSC	M6	30 mm	44.5 mm	75 mm	120°
R6-50-VSC	M6	50 mm	44.5 mm	75 mm	120°
R4-5-VSC	M4	5 mm	11.1 mm	37 mm	90°
R4-10-VSC	M4	10 mm	19 mm	50.8 mm	120°
R4-15-VSC	M4	15 mm	23.8 mm	50.8 mm	120°
R4-20-VSC	M4	20 mm	31.8 mm	50.8 mm	120°

V-Suction Cups with Housing

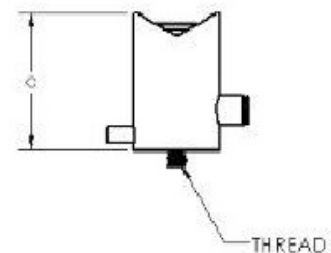
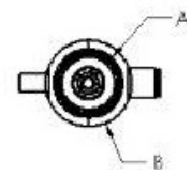

Exposed Suction Cups

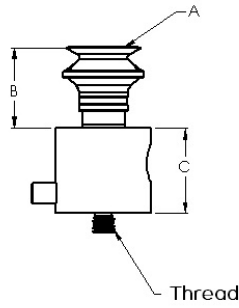

Part Number	Thread	A	B	C
R20-10-EXSC	1/4-20	10 mm	0.85"	1"
R20-20-EXSC	1/4-20	20 mm	0.96"	1"
R20-30-EXSC	1/4-20	30 mm	1.365"	1"
R20-50-EXSC	1/4-20	50 mm	1.72"	1"
R8-10-EXSC	M8	10 mm	21.6 mm	25.4 mm
R8-20-EXSC	M8	20 mm	24.4 mm	25.4 mm
R8-30-EXSC	M8	30 mm	34.7 mm	25.4 mm
R8-50-EXSC	M8	50 mm	43.7 mm	25.4 mm
R6-10-EXSC	M6	10 mm	21.6 mm	25.4 mm
R6-20-EXSC	M6	20 mm	24.4 mm	25.4 mm
R6-30-EXSC	M6	30 mm	34.7 mm	25.4 mm
R6-50-EXSC	M6	50 mm	43.7 mm	25.4 mm

Slide Suction Cups

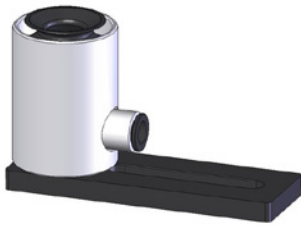

Part Number	Thread	A	B	C	D	E
R20-10-SSC	1/4-20	1"	10 mm	0.75"	2"	3"
R20-15-SSC	1/4-20	1"	15 mm	0.875"	2"	3"
R20-20-SSC	1/4-20	1"	20 mm	1.125"	2"	3"
R8-10-SSC	M8	25.4 mm	10 mm	19 mm	50 mm	76.2 mm
R8-15-SSC	M8	25.4 mm	15 mm	22.2 mm	50 mm	76.2 mm
R8-20-SSC	M8	25.4 mm	20 mm	28.6 mm	50 mm	76.2 mm
R6-10-SSC	M6	25.4 mm	10 mm	19 mm	50 mm	76.2 mm
R6-15-SSC	M6	25.4 mm	15 mm	22.2 mm	50 mm	76.2 mm
R6-20-SSC	M6	25.4 mm	20 mm	28.6 mm	50 mm	76.2 mm

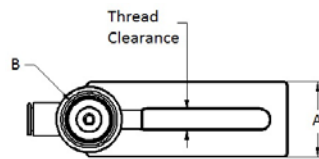
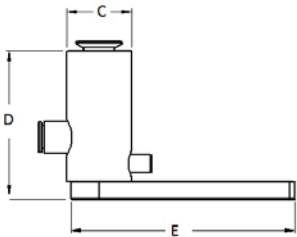

Square V-Suction Cups



Part Number	Thread	A	B	C	D	Inc. Angle
R20-20-SVSC	1/4-20	5"	1.875"	20 mm	3"	120°
R20-50-SVSC	1/4-20	6"	3.5"	50 mm	3"	150°
R8-20-SVSC	M8	127 mm	48.2 mm	20 mm	76.2 mm	120°
R8-50-SVSC	M8	152.4 mm	88.9 mm	50 mm	76.2 mm	150°
R6-20-SVSC	M6	127 mm	48.2 mm	20 mm	76.2 mm	120°
R6-50-SVSC	M6	152.4 mm	88.9 mm	50 mm	76.2 mm	150°

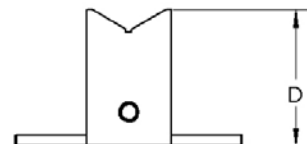
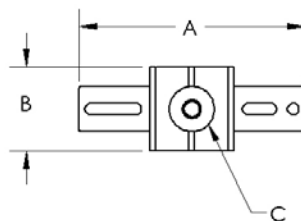

Part Number	Description
R-X10L	X10L Vacuum Pump, 1/8" Male Quick Disconnect
R-9P-M	9 Port Manifold
R-13P-M	13 Port Manifold
R-12-VH	Vacuum Hose, 12" Long
R-18-VH	Vacuum Hose, 18" Long
R-24-VH	Vacuum Hose, 24" Long
R-36-VH	Vacuum Hose, 36" Long
R-60-VH	Vacuum Hose, 60" Long
R-120-VH	Vacuum Hose, 120" Long
R-PMC1002	Open Coupler
R-PMCD1002	Closed Coupler
R-PMCD2202	Straight Hose Barb
R-PMC2302	Elbow Hose Barb

Vacuum Accessories

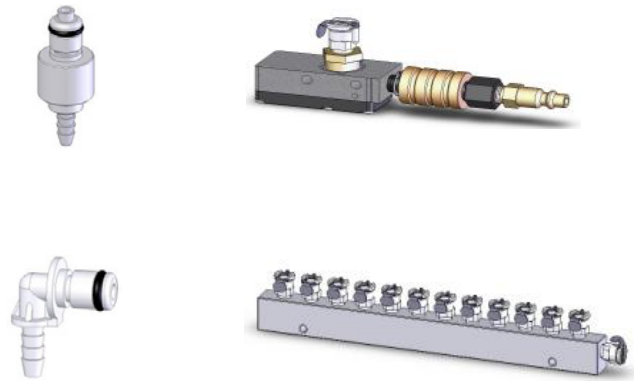

Part Number	Description
R20-DK-45	1/4-20 x 5/8 SHCS with Thumb Screw Cap
R20-HDS-L	1/4-20 Threaded Hold Down Screw Large
R20-HDS-S	1/4-20 Threaded Hold Down Screw Small
R20-AS	1/4-20 Adapter Screw
R8-AS	M8 Threaded Adapter Screw
R8-HDS-L	M8 Threaded Hold Down Screw
R6-DK-45	M6 x 16 mm SHCS with Thumb Screw Cap
R6-HDS-L	M6 Threaded Hold Down Screw Large
R6-AS	M6 Threaded Adapter Screw
R4-AS	M4 Threaded Adapter Screw

Screws & Mounting Pins



Part Number	Description
R20-SCT	Small Component Tray for 1/4-20 Thread
R20-LCT	Large Component Tray for 1/4-20 Thread
R8-SCT	Small Component Tray for M8 Thread
R8-LCT	Large Component Tray for M8 Thread
R6-SCT	Small Component Tray for M6 Thread
R6-LCT	Large Component Tray for M6 Thread
R4-MCT	Mini Component Tray for M4 Thread
AX-BOX	Organizer Box
R-CASE-B	Case for Clamping Kit B (1 Layer)
R-CASE-C	Case for Clamping Kit C (2 Layer)
R-VCT	Vacuum Component Tray

Component Trays & Cases



AX Kits: Aluminum Extrusions



AX-KIT-3

Part Numbers	Description	AX-KIT-1	AX-KIT-2	AX-KIT-3
AX-16	1" x 1" x 6" Arm	2	2	4
AX-112	1" x 1" x 12" Arm			2
AX-1212	1" x 2" x 12" Arm	1	2	
AX-126	1" x 2" x 6" Arm			2
AX1-2-12	1" x 2" x 12" Arm			4
AX-218	2" x 2" x 18" Arm	1	1	3
AX-224	2" x 2" x 24" Arm	2	2	4
AX-230:	2" x 2" x 30" Arm			2
AX-236	2" x 2" x 36" Arm		2	4
AX-242	2" x 2" x 42" Arm			2
AX20-2AF	2" W. Angle Foot To Base Plate with 1/4-20 Thread	4	6	16
AX-2AB4	2" W. Angle Bracket with 4 Holes	2	2	8
AX-2AG8	2" Angle with 8 Holes	2	2	6
AX-1AG4	1" Wide Angle Gusset with 4 Holes	2	2	4
AX-2AG8	2" Wide Angle Gusset with 8 Holes	2	2	12
AX-21AT6	2" Wide Angle Transition with 6 Holes	1	2	6
AX-JP8	2" Wide Joining Plate with 8 Holes			4
AX-12AB	12" Angle Brace		2	4
AX-15AB	15" Angle Brace			2
AX20-33	3" x 3" x 1/2" Grid Plate, 1/4-20 Threaded Holes	2	4	8
AX20-36	3" x 6" x 1/2" Grid Plate, /4-20 Threaded Holes	1	3	6
AX-1-C	1" sq. End Cap	2	2	4
AX-12-C	1" x 2" End Cap	1	2	6
AX-2-C	2" sq. End Cap	4	6	16
AX-NUT	T-Nut	86	100	320
AX-PVNUT	Pivot T-Nut	8	12	32
AX-BOX	Organizer Box	1	1	1
Total Components		39	155	482

Extrusion Accessories

Part Number	Description
AX-16	1" sq x 6" Arm
AX-112	1" sq. x 12" Arm
AX-126	1" x 2" x 6" Arm
AX-1212	1" x 2" x 12" Arm
AX-1218	1" x 2" x 18" Arm
AX-1224	1" x 2" x 24" Arm
AX-26	2" sq. x 6" Arm
AX-218	2" sq. x 18" Arm
AX-224	2" sq. x 24" Arm
AX-230	2" sq. x 30" Arm
AX-236	2" sq. x 36" Arm
AX-242	2" sq. x 42" Arm
AX-248	2" sq. x 48" Arm
AX-260	2" sq. x 60" Arm
AX-324	3" sq. x 24" Arm
AX-336	3" sq. x 36" Arm
AX-348	3" sq. x 48" Arm
AX-360	3" sq. x 60" Arm

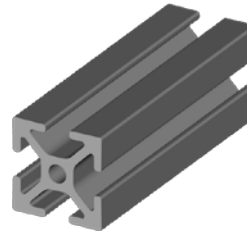
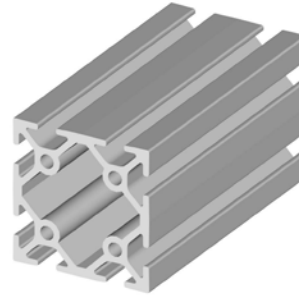

Arms

Part Number	Description
AX-NUT	T-Nut
AX-3NUT	T-Nut
AX-PVNUT	Pivot T-Nut

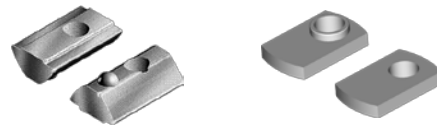

T-Nuts

Part Number	Description
AX20-2AF	2" Wide Angle Foot to Base Plate (1/4-20 Threads)
AX8-2AF	2" Wide Angel Foot to Base Plate (M8 Threads)



Angle Foot

Part Number	Description
AX-JP6	Joining Plate with 6 Holes
AX-JP8	Joining Plate with 8 Holes
AX-JP12	Joining Plate with 12 Holes

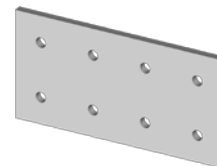

Joining Plate

Part Number	Description
AX-1AB4	1" Wide Angle Bracket with 4 holes
AX-2AB4	2" Wide Angle Bracket with 4 holes
AX-2AB6	2" Wide Angle Bracket with 6 Holes
AX-2AB8	2" Wide Angle Bracket with 8 Holes
AX-2AB8	2" Wide Angle Bracket with 8 Holes



Angle Bracket

Angle Brace



Part Number	Description
AX-12AB	12" Angle Brace
AX-15AB	15" Angle Brace
AX-18AB	18" Angle Brace

Angle Gusset



Part Number	Description
AX-1AG4	1" Wide Angle Gusset with 4 holes
AX-2AG4	2" Wide Angle Gusset with 4Holes
AX-2AG8	2" Wide Angle Gusset with 8 Holes
AX-3AG4	3" Wide Angle Gusset with 4 Holes
AX-3AG8	3" Wide Angle Gusset with 8 Holes

Angle Transition

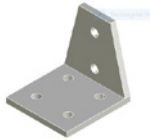

Part Number	Description
AX-21A6	2" Angle Transition with 6 Holes
AX-23A8	2" Angle Transition with 8 Holes

Grid Plate



Part Number	Description
AX20-33	3" x 3" x 1/2" Aluminum Plate with 1/4-20 Threaded Holes
AX20-36	3" x 6" x 1/2" Aluminum Plate with 1/4-20 Threaded Holes
AX8-9090	90mm x 900mm x 13mm Aluminum Plate with M8 Threaded Holes
AX8-90165	90mm x 165mm x 13mm Aluminum Plate with M8 Threaded Holes

End Caps

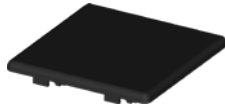

Part Number	Description
AX-1-C	1" x 1" End Cap
AX-12-C	1" x 2" End Cap
AX-2-C	2" x 2" End Cap
AX-3-C	3" x 3" End Cap

Rotating Base

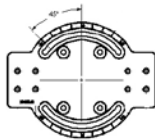

Part Number	Description
AX20-RB	5" x 5" Rotational Base

Top Plate

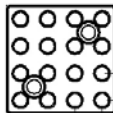

Part Number	Description
AX20-TP	2" x 2" x 1/2" Top Plate

Case



Part Number	Description
AX-BOX	Organizer Box

Screws

Part Number	Description
AX20-BH-50	1/4-20 Button Head Cap Screw
AX20-BH-63	1/4-20 Button Head Cap Screw
AX8-BH	M8 Button Head Cap Screw
AX20-SH-50	1/4-20 Socket Head Cap Screw
AX20-SH-63	1/4-20 Socket Head Cap Screw
AX8-SH	M8 Socket Head Cap Screw

PLATE DIMENSIONS AND MOUNTING HOLE LOCATIONS

MACHINE: _____

PLATE MATERIAL: _____

FINISH: _____

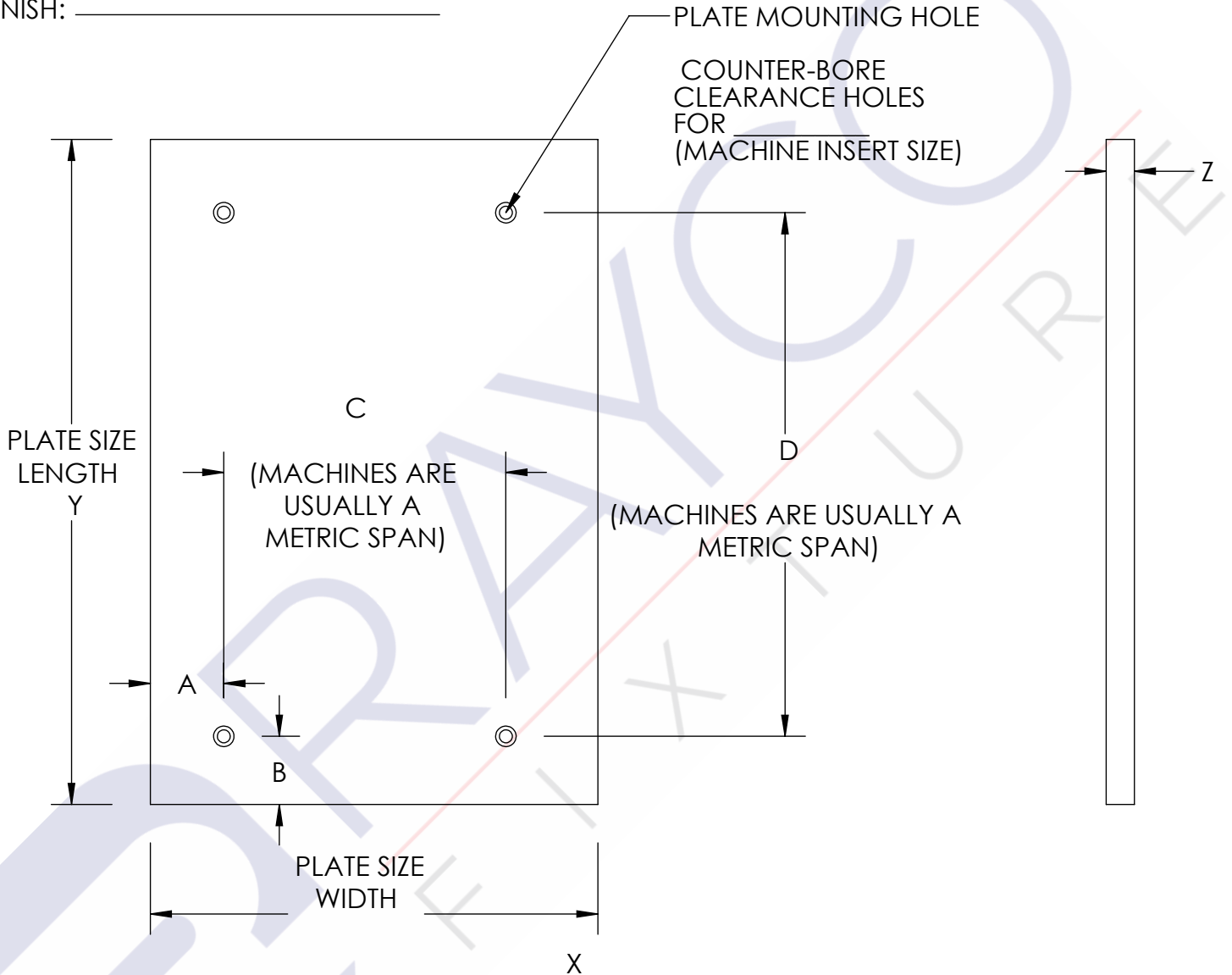

X: _____ PLATE WIDTH

Y: _____ PLATE LENGTH

Z: _____ PLATE THICKNESS

A: _____ DISTANCE FROM PLATE LEFT EDGE TO 1ST MOUNTING HOLE

B: _____ DISTANCE FROM PLATE BOTTOM EDGE TO 1ST MOUNTING HOLE

C: _____ SPAN OF BETWEEN MOUNTING HOLES IN PLATE X

D: _____ SPAN BETWEEN MOUNTING HOLES IN PLATE Y

Rayco Fixture, Inc.

5520 Bridgewood Dr.
Sterling Heights MI 48310

Office: (586) 795-2884

Fax: (586) 795-3260

Email: sales@raycofixture.com

